

Talking about trees, scope and concepts

Philipp Cimiano¹ and Uwe Reyle²

¹ Institute for Applied Computer Science and Formal Methods,
University of Karlsruhe

² Institute for Computational Linguistics, University of Stuttgart

1 Introduction

Language can be ambiguous at all levels – at the level of the word, of the phrase, of the sentence, as well as of the text or dialogue. The source of ambiguity is often lexical or morphological, but ambiguities also emerge when passing from one level of linguistic analysis – morphology, syntax, semantics, pragmatics – to another. This transition from one level of representation to another can, however, also have the opposite effect. It may eliminate ambiguities rather than increase them. The ultimate task for both computational and theoretical linguistics must therefore not only be to describe the sources of ambiguity but also to identify the ways in which these ambiguities can be eliminated again.

Any solution of the problem of disambiguation will depend on (i) the way different types of ambiguities are represented, if they are, and (ii) the mode of representation for the non-ambiguous case. *Representational* approaches represent ambiguities by specific construals. For most of them the modes of ambiguity representation subsumes the mode for disambiguated representations, as is the case for packed representations, feature structures, or UDRSs. *Descriptive* approaches to ambiguity control move from structural representations to descriptions thereof. Linguistic representations are considered here as determined by a description (in form of a logical theory derived from the input and containing general linguistic knowledge) from which the actual representation or the set of possible representations must be derived. (For syntactic structures such descriptions are given in [3, 12, 13, 15], an extension to type-theoretical semantics can be found in [14], and in [4] we proposed a treatment of lexical ambiguities by integrating ontological knowledge to express selectional restrictions of verbs).

Representational and descriptive approaches do, however, not exclude each other. Suppose ambiguities are explicitly represented by some construal, as is the case for, e.g., the partial ordering of UDRS-components. Then a UDRS representing an ambiguous sentence may be derived by a logical description grammar approach as the unique model satisfying the description. This model is related to the set of models representing the readings of the sentence by the different ways to strengthen the partial ordering of UDRS-components to linear ones. If the logical theory contains enough

information, then a linear model will be derived in the first place. But if this is not the case the model will represent a partial order of scope relations.

This analogy between representational and descriptive approach is also pointed out in [14]. Muskens' semantic representation language does, however, not contain any constructs to talk about scope ambiguities explicitly. In his system scope ambiguities are dealt with syntactically by a quantifying-in analysis. For scopally ambiguous sentences the set of additional S-nodes introduced by this quantifying-in mechanism can only be partially ordered and hence structures are derived that may be considered as isomorphic to UDRSs.

We will show in Section 3 that as it stands Muskens' syntactic approach to talk about quantifier ambiguities lacks expressive power to be linguistically adequate and that any extension of it will require to talk about scope relations explicitly. This may well be done by syntactic means, but according to our view it is more natural to do this at its proper place, namely in the semantic representation language.

In this paper we present an extension of Muskens' logical description grammar ([14]) that treats syntax and semantics as well as ontological knowledge on a par. Syntactic, semantic and ontological information directly interact with each other to restrict the (logical) models representing the meaning of a given expression. As semantic representation language we use (U)DRT. This allows direct reasoning on the constructed underspecified representations as in [11, 18]. Our long-term goal is to develop a system which on the one hand is able to reason on the basis of linguistic and world knowledge in order to select the appropriate readings for an ambiguous expression. On the other hand we are especially concerned with the inferences that can be drawn from a certain input sentence. These aims are quite orthogonal to the ones of [14], whose focus is the formal relation between LTAG-like syntactic theories, descriptive approaches to underspecification and logic, the XTAG research group¹, which is concerned with developing a large-coverage parser as well as [7] who focus on the efficient processing of dominance constraints.

2 The Logical Description Grammar Approach

Muskens' Logical Description Grammar is to a great extent based on LTAG [9] and D-Tree grammars [17], but offers a declarative account of the tree operations used in these formalisms. Muskens distinguishes three kinds of descriptions: (i) *general descriptions*, (ii) *input descriptions*, and (iii) *lexical descriptions*.

ad(i): General descriptions are axioms defining linguistic tree structures by means of the two binary relations proper dominance \triangleleft^+ and linear precedence \prec .² In addition, each node k of a tree is (a) labeled by its part-of-speech type, e.g. $l(k) = dp$, where l is the labeling function, and is (b) assigned a positive and negative anchor, $\alpha^+(k)$ and $\alpha^-(k)$. The positive anchor of a node k is required to be lexical by the axiom $\forall k \text{ lex}(\alpha^+(k))$; the negative anchor requires the same for all nodes except for the root

¹<http://www.cis.upenn.edu/~xtag/>

²For the exact formulation of these axioms we refer the reader to [14] and [2].

node (i.e. $\forall k(k = r \vee lex(\alpha^-(k)))$) which is negatively anchored to itself by the axiom $\alpha^-(r) = r$. The role of these anchoring functions is to enforce a pairing of nodes that are only positively or negatively marked in the elementary tree descriptions of lexical entries such that each node of the resulting tree is marked both positive and negative.

ad(ii): Input descriptions are constructed on the basis of the sentence to be analyzed. The input description of sentence (1) is given in (2). It states that there are exactly 5 lexical nodes carrying the lexemes of the sentence which are linearly ordered by \prec .

- (1) Every man loves a woman.
- (2) $\exists n_1, n_2, n_3, n_4, n_5 (n_1 \prec n_2 \prec n_3 \prec n_4 \prec n_5 \wedge$
 $every(n_1) \wedge man(n_2) \wedge loves(n_3) \wedge a(n_4) \wedge woman(n_5) \wedge$
 $\forall n(lex(n) \leftrightarrow n = n_1 \vee n = n_2 \vee n = n_3 \vee n = n_4 \vee n = n_5))$

ad(iii): Lexical descriptions associate with each lexical item semantically labeled *elementary tree descriptions*.³

- (3) $\forall k[man(k) \rightarrow (cn(k) \wedge l(k) = NP \wedge \alpha^+(k))]$
- (4) $\forall k[every(k) \rightarrow det(k) \wedge l(k) = DET \wedge \exists k_2, k_3, k_4, k_5 (l(k_2) = DP \wedge$
 $l(k_3) = NP \wedge l(k_4) = S \wedge l(k_5) = S \wedge \Gamma(k, k_2, k_3, k_4, k_5) \wedge$
 $\sigma(k_5) = \prod u(\sigma(k_3)(u) \supset \sigma(k_4)) \wedge \sigma(k_2) = u)]$
- (5) $\forall k[love(k) \rightarrow tv(k) \wedge \exists k_2, k_3, k_4, k_5, k_6 (l(k) = V \wedge l(k_2) = VP \wedge l(k_3) =$
 $DP \wedge l(k_4) = VP \wedge l(k_5) = S \wedge l(k_6) = DP \wedge \Gamma(k, \dots, k_6) \wedge \sigma(k_5) =$
 $\sigma(k_4)(\sigma(k_6)) \wedge \sigma(k_2) = \lambda v love'(v, \sigma(k_4)))]$

$\Gamma(k, \dots)$ abbreviates a set of relations expressed in terms of immediate dominance \triangleleft , dominance, \triangleleft^* , α^+ and α^- . These relations are graphically represented in 6. (Conditions of the form $l(k_i) = C \wedge \alpha^v(k_i)$ are abbreviated with C_i^v . If not needed we omit v in our graphical representations.)

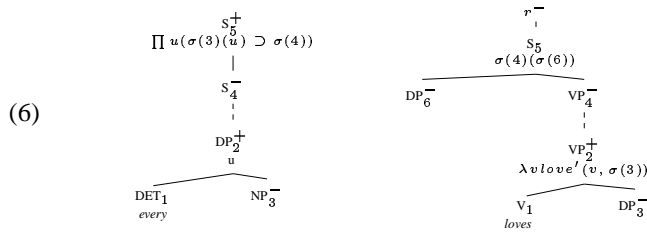

The general axioms, the input description and the descriptions of the elementary trees form a logical theory and the models of this theory correspond to all the possibilities

³We use an extended notion of *elementary tree description* here because it also incorporates the information given in Muskens' *classifying descriptions*. We have already shown in [4] that elementary tree descriptions cannot be based on part of speech tags alone as is done in [14]. Furthermore we omit indication of semantic types.

of successfully selecting the appropriate elementary trees for each word in the input description as well as combining these trees to yield a syntactic and semantic representation of the sentence under consideration. Parsing thus boils down to identifying positively anchored nodes with negatively anchored ones such that category, tree and order information is respected.

Note that the semantics of a lexical item is not associated with its leaf category but with the root node of its lexical tree. For determiners the domain of locality is extended to include two additional S nodes in order to treat scope ambiguities by quantifying-in. The genuine semantics of the determiner is thus associated with the root S-node, and the semantic contribution of the DP-node is a variable – the *referential variable* as we will name it – coindexed with the one that is quantified over by the formula at the root S-node. Verb semantics is such that the relation expressed by the verb is combined with the referential variable $\sigma(3)$ of the object DP at VP-level and with the variable $\sigma(6)$ of the subject DP at S-level.

For a sentence like (1) all DP^- nodes may be provably identified with some DP^+ by the logical theory. But for the S-nodes this is not the case. No S^+ , S^- pair may be identified by the theory. Hence two models (corresponding to the two readings of (1)) are possible, which are depicted by the intermediate representation in (7).

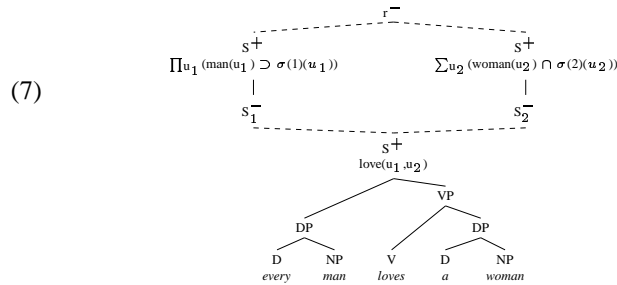

As argued by Muskens compact representations as the one in (7) are structurally similar to the underspecified scope representations in UDRT. We will show in the next section that this similarity cannot be maintained for examples involving partial orders of scoping relations and clause boundedness. A proper treatment of these phenomena requires to talk about scoping relations explicitly.

3 Scope Ambiguities

We first note that if scope ambiguity is dealt with by this lexicalized version of quantifying-in in the lexical trees not only of determiners but also of any other scope bearing lexical elements – such as negation, adverbial quantifiers, temporal and locating adverbs, perfect and other aspectual operators – must be extended by an additional pair of S nodes. (A so extended lexical tree for the temporal adverbial quantifier *often* is shown in (10.a) below.) Although this is a viable option the introduction of additional node pairs is syntactically unmotivated (viz. [5]).

Second, and more important, there is the problem of clause boundedness. Muskens' approach treats scope ambiguity as a long distance phenomenon. It is well known,

however, that genuine quantification is clause bounded. The NP *some people* in (8) cannot be interpreted as having narrow scope wrt. any of the quantifying phrases in the embedded clauses.

- (8) (a) *Some people think that most pupils know at least two languages.*
 (b) *Some people doubt that they are often wrong.*

In order to talk about clause boundedness in lexical entries like the one in (10.a) (and similarly for non-temporal quantification) adjunction of their uppermost S^+ -nodes must be restricted to the clause in which the quantifier occurs.

The same point can be made wrt. temporal reference. In sentences like (9) the use of past tense indicates that the relevant period during which there were many cheating events by Tara must lie in the past.

- (9) *Tara often cheated.*

If one assumes that this period is represented by a quantificational state introduced by *often* (compare (18)),⁴ it follows that the temporal information given by tense morphology must have wide scope over the quantification *often* expresses. The lexical trees for verbal entries must therefore be extended by an additional pair of S-nodes just as those for scope bearing elements are. But furthermore we have to guarantee that none of the other S-node pairs introduced by lexical elements occurring in the same clause as the verb may in any model dominate the uppermost S-node of the verb. This means that the uppermost S-node of the verbal lexical tree has to be specified as the supremum of all other S-nodes of the same clause. And hence (i) we must talk about the partial order of the set of quantifying-in S-node pairs of a given clause, and (ii) require this order to be an upper-semilattice.

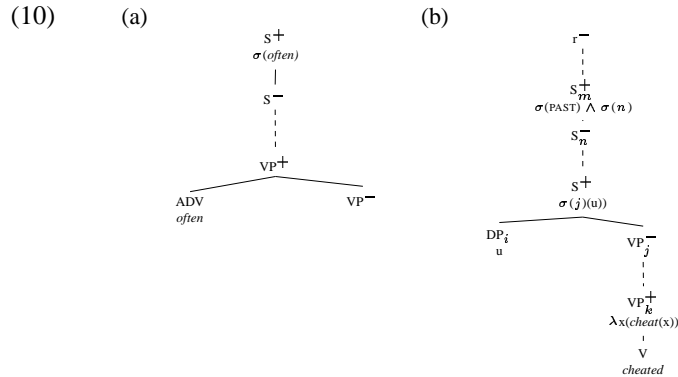

To sum up: a proper treatment of clause boundedness within Muskens' framework is only possible if the relation \triangleleft^* of dominance forms a lattice (the zero-element being contributed by the verb) when restricted to the set of S-nodes of a given clause. Hence scope relations must be represented and talked about explicitly – exactly as they are in UDRT.

⁴This state is characterized by the condition that the quantification holds when restricted to its duration – more explicitly, the proportionality relation denoted by the quantifier should hold between the set of relevant satisfiers within this duration of its restrictor and the set of satisfiers within this duration of (its restrictor and) nuclear scope. For a treatment of quantification along these lines in DRT and UDRT see, e.g. [8],[6], or [19].

4 Talking about Scope

To implement the requirements of the last section we first eliminate the additional S-node pairs introduced by Muskens to deal with scope ambiguities by quantifying in. Second, we introduce an additional relation \leq_U on the set of nodes N which corresponds to the dominance relation between UDRS-components in standard UDRT. We thus take the nodes themselves as labels of UDRS-components which are associated with these nodes by means of a function σ . This function is partial, because not every syntactic node bears a semantics.

$$(11) \quad \sigma : N \rightarrow UDRS, \text{ where } UDRS \text{ is the set of UDRS-components}$$

On the other hand complex UDRS-components introduce nodes for which there is no syntactic correspondence, i.e. for which the function l is not defined. This is so for all complex UDRS-components, i.e. components that contain conditions built up with one or more sub-DRSs as, e.g., the component $\sigma(\text{scope}(2))$ associated with node 2 in the lexical tree of the determiner *every* as depicted in (14). We assume that this duplex-condition introduces two nodes 2_1 and 2_2 such that $2_1 \leq_U 2$ and $2_2 \leq_U 2$ holds. We will refer to these nodes by means of functions *restr* and *scope*, respectively. I.e. the UDRS-component $\sigma(2)$ in (14) is more explicitly described by the

conditions $\text{restr}(2)=2_1, \text{scope}(2)=2_2, \sigma(2_1)=\boxed{u}$. Note that there is no value specified for $\sigma(2_2)$. $\sigma(2_2)$ will get a value only via the identification of 2_2 with one of the nodes it immediately dominates, when the partial order is strengthened to a linear one. For UDRS-components containing only atomic conditions we assume $\text{restr}(n) = \text{scope}(n) = n$.

To accommodate binding of argument variables we introduce a (partial) function μ that associates discourse referents to particular nodes of elementary trees. Any identification of positively and negatively marked syntactic nodes will thus induce an identification of the discourse referents associated to them.

$$(12) \quad \mu : N \rightarrow DREF, \text{ where } DREF \text{ is the set of discourse referents}$$

Given these additional functions on nodes the elementary trees in (6) now have the form in (14). UDRS-components $\sigma(n)$ and discourse referents $\mu(n)$ are depicted underneath the syntactically labeled node n . The dotted line in the tree for the determiner says that the restrictor is \leq_U -superordinate to the contribution of the NP, i.e. $3 \leq_U 2$. Note that the tree for the verb does not specify any \leq_U -relations. These will be implied by the following axioms, which have the advantage to apply not only to argument phrases of the verb but also to adjuncts adjoined to VP. Let XP range over DP and ADJ. Then any UDRS-component introduced by a node dominated by S_m (or adjoined to it) is \leq_U -subordinate to m and is \leq_U -superordinated to the semantic contribution of the verb.

$$(13) \quad \forall m, n, k, r (l(m) = S \wedge l(n) = S \wedge l(r) = XP \wedge l(k) = V \wedge k \triangleleft^* m \triangleleft^* n \wedge \neg \exists x (l(x) = S \wedge k \triangleleft^* x \triangleleft^* m) \wedge \forall x (m \triangleleft^* x \triangleleft^* n \rightarrow l(x) = S) \wedge r \triangleleft^* n \rightarrow k \leq_U r \leq_U m)$$

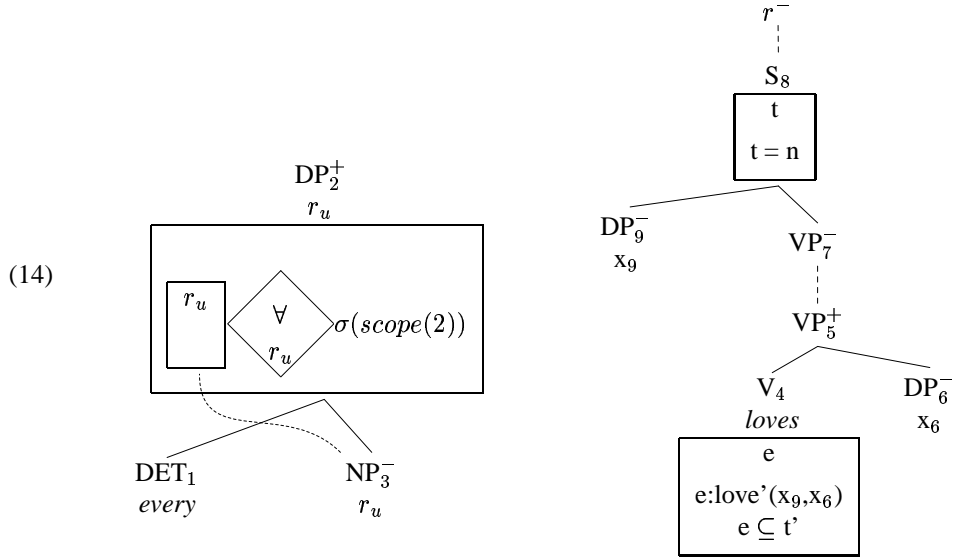

We give the official notation of Section 2 only for the determiner *every*. The formula describing the elementary tree for *love* is left as an exercise to the reader.

(15)

$$\forall n_0 [\text{every}(n_0) \rightarrow \exists r_u, n_1, n_{11}, n_2, n_{12} (l(n_0) = DET \wedge l(n_1) = DP \wedge l(n_2) = NP \wedge \Gamma(n_0, n_1, n_2) \wedge \text{restr}(n_1) = n_{11} \wedge \text{scope}(n_1) = n_{12} \wedge n_{12} \leq_U n_1 \wedge n_{11} \leq_U n_1 \wedge n_2 \leq_U n_{11} \wedge \mu(n_2) = r_u \wedge \mu(n_3) = r_u$$

$$\wedge \sigma(n_1) = \sigma(n_{11}) \left[\sigma(n_{11}) \left[\forall \right] \sigma(n_{12}) \right] \wedge \sigma(n_{11}) = \left[r_u \right]]]$$

The equation $\mu(n_2) = r_u$ serves to bind the subject argument position of $e:\text{love}'(x_9, x_6)$ in case node 2 in (14) is equated with node 9. And similarly $\mu(n_3) = r_u$ will bind the argument of the entry for the noun with which *every* combines.

Binding of free variables becomes more complicated, however, for the case of adjuncts. Consider the elementary tree for *often* in 18 that is needed for sentence-initial occurrences as in the sentence *Often Tara cheated*. First note that identification of S_n^- with the root S-node of the verb induces that the semantics $\sigma(n)$ of *often* is located between the bottom and top node of the UDRS that is built up for (9) and is depicted in (18.b). (For adjunction to S this relation has to be made explicit, because it is not covered by (13).) Second, there is no way to talk about the binder of the variables t_s and t' in the lexical trees of *often* and the verb, and hence that in (13.b) they are not bound by t_q and t , respectively.

The principles that govern the binding of these temporal discourse referents cannot be associated with any lexical tree because their extended locality domains are too restricted to accommodate this. The binding principles for these variables must therefore be of a more general sort (like, e.g., the principles in (13)), and must be formulated wrt. the UDRS that is built up for a particular clause.

To deal with binding of discourse referents we first define two functions $declV$ and $freeV$ on the set of nodes.

- (16) $declV := \sigma_1$, where σ_1 is the first projection of σ , i.e. yields the universe of the UDRS-component given by σ .
- (17) $freeV := FV(\sigma_2)$, where σ_2 is the second projection of σ , and FV is a function yielding the set of free variables occurring in this set of UDRS-conditions.

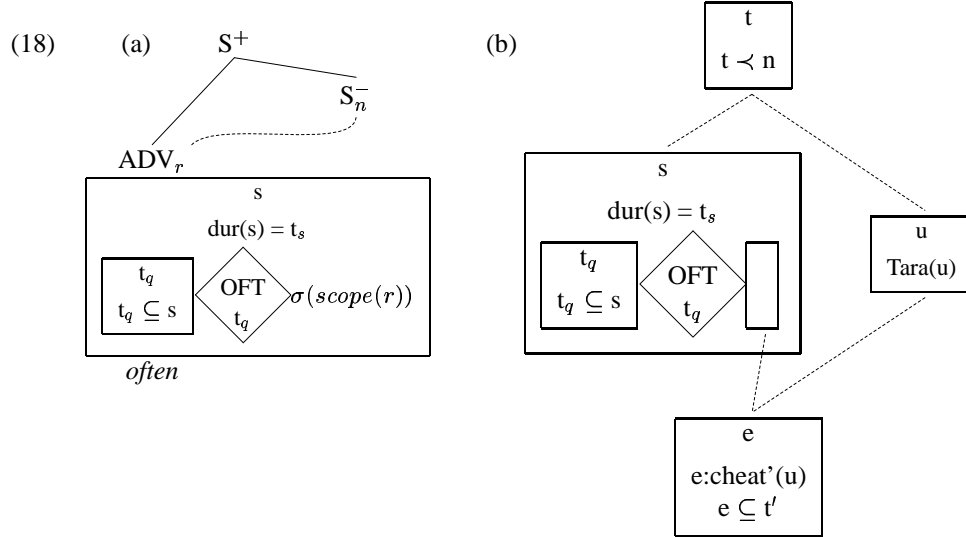

Second, we introduce anchoring functions α_r^+ and α_r^- making sure that discourse referents are negatively and positively anchored. Note that this axioms represent a semantic analogo to the axioms in [14] requiring nodes to be positively and negatively anchored. The axiom in 21 guarantees properness of UDRSs.⁵

- (19) $\forall x, n (x \in freeV(n) \rightarrow \alpha_r^-(x))$
- (20) $\forall x, n (x \in declV(n) \rightarrow \alpha_r^+(x))$
- (21) $\forall x (x \in REF \rightarrow \alpha_r^-(x) \wedge \alpha_r^+(x))$, where REF is the set of discourse referents

Binding of discourse referents by virtue of (21) is subject to two further constraints. The first states that bindings must preserve accessibility \leq_U^{acc} between UDRS-components.⁶

- (22) $\forall x, n, m (x \in declV(n) \wedge x \in freeV(m) \rightarrow m \leq_U^{acc} n)$

⁵Recall that UDRSs are proper if no disambiguation contains any free variable; for a definition see [18].

⁶We may assume that \leq_U^{acc} results from \leq_U by adding all pairs of the form $\langle scope(n), restr(n) \rangle$.

The second additional constraint is that unification must always be between discourse referents of the same type. In our example the discourse referents that still have to be bound in (18.b) serve to temporally locate the eventuality variables, and hence may only be bound by temporally locating discourse referents. This type uniqueness will be guaranteed automatically if we associate appropriate concepts with these discourse referents. The next section discusses concept assignments on a more general basis.

5 Talking about Concepts

Lexical and structural ambiguities can often be resolved when passing to other levels of analysis. Take for instance the example in (23) which we already discussed in [4].

(23) *Ginger croaked.*

Here, *Ginger* can belong to different syntactic categories and thus also have different interpretations. We assume here that *Ginger* is either : (i) a proper noun thus denoting a person, (ii) a common noun denoting a root or (iii) an adjective denoting a colour. Further, *croaked* has also two readings: a dying and a cawing one. However, the only actually perceived readings are the ones in which a living being either died or cawed. As argued already in [4], according to the LDG approach we would get 6 semantically different readings of 23, of which only two are actually perceived. The reason is that the theory does not take ontological nor lexical semantical information into account in order to reduce ontologically or semantically ill-formed readings.

A similar point can be made for structural ambiguities:

(24) *John met a man from Panama.*

The sentence is structurally ambiguous as the prepositional phrase *from Panama* can be either attached to the NP *man* or to the VP of the meeting event. This ambiguity corresponds again to two logical models in the LDG approach (compare the example *John saw a man with a telescope* in [14].) However, when moving to a semantical analysis of the sentence, the structure corresponding to the VP-attachment should be ruled out. This again, can only be accomplished if we include ontological information into the LDG approach.

Thus we need an ontology model which allows us to explicitly talk about concepts and represent selectional restrictions. We adopt for this purpose the model described in [4], in which the concepts of a set C are partially ordered according to their generality/specificity with respect to a relation \leq_C with a standard subsumption semantics. Thus, in our approach discourse referents are typed with ontological concepts as in [1]. In fact, we assign concepts to discourse referents via the function $\tau : REF \rightarrow C$. For example, the fact that discourse referent r refers to a concept *man* is expressed by $\tau(r) = man$. Further, we can express conceptual constraints on discourse referents by stating that the concept to which a certain discourse referent refers is subsumed by some concept C by the predicate \leq_C as $\tau(r) \leq_C c$. The assignment of concepts to discourse referents is functional, i.e

$$(25) \quad \forall r, c, c' (\tau(r) = c \wedge \tau(r) = c' \rightarrow c = c')$$

In generative lexicon theories [16], the assignment of conceptual structures to words is typically much more complex and not restricted to one unique concept. However, a systematic account of lexical semantics in line with generative theories in order to handle phenomena such as regular polysemy, context-based word interpretation, creative word usage etc. is out of the scope of this paper and will be addressed in a future contribution.

The elementary tree descriptions for *Ginger* and *croaked* in our extension are thus as follows:

$$\begin{aligned}
 (26) \quad & \forall n_0 [Ginger(n_0) \rightarrow \exists s, r (\mu(n_0) = r) \wedge \\
 & \quad ((l(n_0) = PN \wedge \sigma(n_0) = \boxed{\begin{array}{c} r^+ \\ Ginger(r) \\ \tau(r) = person \end{array}} \wedge \alpha^+(r)) \\
 & \quad \vee \\
 & \quad (l(n_0) = ADJ \wedge \sigma(n_0) = \boxed{\begin{array}{c} ginger'(r^-) \\ \tau(r) = colour \end{array}} \wedge \alpha^-(r)) \\
 & \quad \vee \\
 & \quad (l(n_0) = CN \wedge \sigma(n_0) = \boxed{\begin{array}{c} ginger''(r^-) \\ \tau(r) root \end{array}} \wedge \alpha^-(r)) \quad] \\
 \\
 (27) \quad & \forall n_0 [croaked(n_0) \rightarrow \exists t, t', r_{subj}, e, n_1, n_2, n_3, n_4 \\
 & \quad (l(n_4) = S \wedge l(n_3) = DP \wedge l(n_2) = VP \wedge l(n_1) = VP \wedge \Gamma(n_0, \dots, n_4) \wedge \\
 & \quad \tau(r_{subj}) \leq_C animate \wedge \alpha^+(t) \wedge \alpha^-(t') \wedge \alpha^+(e) \wedge \alpha^-(e) \wedge \alpha^-(r_{subj}) \wedge \\
 & \quad \mu(n_4) = r_{subj} \wedge n_0 \leq_U scope(n_4) \wedge \\
 & \quad \sigma(n_4) = \boxed{\begin{array}{c} t^+ \\ t^+ < n \end{array}} \wedge ((\sigma(n_0) = \boxed{\begin{array}{c} e \\ e \subseteq t' \\ e:croak'(r_{subj}^-) \end{array}} \wedge \tau(e) = dying) \\
 & \quad \vee \\
 & \quad (\sigma(n_0) = \boxed{\begin{array}{c} e \\ e \subseteq t' \\ e:croak''(r_{subj}^-) \end{array}} \wedge \tau(e) = cawing) \\
 & \quad)])
 \end{aligned}$$

By explicitly assigning conceptual constraints to discourse referents we thus reduce the readings of *Ginger croaked* to the actually perceived ones, yielding two models which are compactly represented in Figure 1 (left).

Concerning (24), the crucial logical description is the one for *from* in (28). Syntactically, the elementary tree for *from* can thus either attach to a VP or an NP. Further, *from* has two readings, one in the sense of 'origin of movement' and one in the sense of 'precedent of'. The first reading requires that the discourse referent of the first semantic representation is of type *movement*, while in the second reading requires it to be a *physical_entity*. Due to these constraints, assuming that *meeting* is not a *movement*, we have thus reduced the two readings to the NP-attaching one, which is depicted in Figure 1 (right).

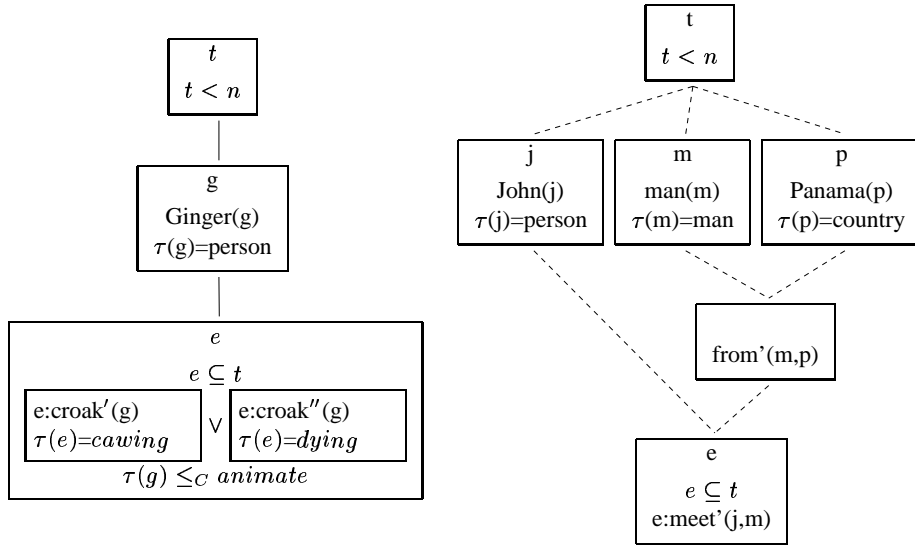
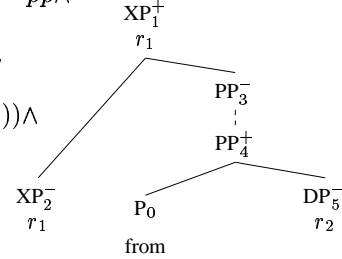

Figure 1: Compact representation of the two models for *Ginger croaked* and under-specified representation of *John met a man from Panama*.

(28)

$$\begin{aligned}
& \forall n_0 [from(n_0) \rightarrow \exists r_1, r_2, n_1, n_2, n_3, n_4, n_5 \\
& ((l(n_1) = l(n_2) = vp \vee l(n_1) = l(n_2) = np) \wedge l(n_3) = pp \wedge \\
& l(n_4) = pp \wedge l(n_5) = dp \wedge \Gamma(n_0, n_1, n_2, n_3, n_4, n_5) \wedge \\
& ((\sigma(n_0) = \boxed{\text{origin}'(r_1^-, r_2^-)} \wedge \tau(r_1) \leq_C \text{movement}) \vee \\
& (\sigma(n_0) = \boxed{\text{from}'(r_1^-, r_2^-)} \wedge \tau(r_1) \leq_C \text{physical_entity})) \wedge \\
& r_2 \leq_C \text{place} \wedge \sigma(n_1) = \sigma(n_2) \wedge n_0 \leq_U n_5 \wedge \\
& \wedge n_0 \leq_U n_2 \wedge \alpha^-(r_1) \wedge \alpha^-(r_2) \wedge \\
& \mu(n_1) = \mu(n_2) = r_1 \wedge \mu(n_5) = r_2]]
\end{aligned}$$



6 Conclusion

We have shown in this paper that with our extension of the LDG approach to additionally talking about semantic dominance, we overcome on the one hand problems inherent in Muskens' LDG approach related to the clause boundedness of quantifiers. On the other hand, by talking about concepts and ontological dominance we are able to reduce the readings of lexically and structurally ambiguous expressions. Though we follow and extend the LDG approach, our descriptions are not primarily of a syntactic nature. In our approach, semantic, syntactic and ontologic dominance interact with each other to produce one or more models for the input sentence.

As a by-product, we have also shown that the (U)DRT construction algorithm ([10]) can be given a pure declarative flavour (compare also [20] for such a declarative approach at the discourse level). Further, we think that our approach can be generalized

to give a UDRT-based semantics for LTAG ([9]).

References

- [1] N. Asher and J. Pustejovsky. Metaphysics of words in context. submitted to *Journal of Language and Information*.
- [2] R. Backofen, J. Rogers, and K. Vijay-Shanker. A first-order axiomatization of the theory of finite trees. *Journal of Logic, Language and Computation*, 4:5–39, 1995.
- [3] P. Blackburn, C. Gardent, and W. Meyer-Viol. Talking about trees. In *Proceedings of the Sixth Conference of the European Chapter of the Association for Computational Linguistics*, pages 21–29, 1993.
- [4] P. Cimiano and U. Reyle. Ontology-based semantic construction, underspecification and disambiguation. In *Proceedings of the Prospects and Advances in the Syntax-Semantic Interface Workshop*, 2003.
- [5] R. Cooper. *Quantification and Syntactic Theory*. Reidel, Dordrecht, Dordrecht, 1983.
- [6] H. de Swart and A. Molendijk. Negation and the temporal structure of narrative discourse. *Journal of Semantics*, 16(1), 1999.
- [7] R. Fuchs, A. Koller, J. Niehren, and S. Thater. Minimal recursion semantics as dominance constraints: Translation, evaluation, and analysis. In *Proceedings of the 42th Meeting of the Association for Computational Linguistics*, pages 247–254, 2004.
- [8] J. van Genabith, H. Kamp, and U. Reyle. Discourse representation theory. an updated survey. 2004.
- [9] A.K. Joshi and Y. Schabes. Tree-adjoining grammars. In *Handbook of Formal Languages*, volume 3, pages 69–124. Springer, 1997.
- [10] H. Kamp and U. Reyle. *From Discourse to Logic*. Kluwer, 1993.
- [11] H. Kamp and U. Reyle. A calculus for first order discourse representation structures. *Journal of Logic, Language, and Information*, 5:297–348, 1996.
- [12] A. Koller and J. Niehren. Constraint programming in computational linguistics. In *Proceedings of LLC8*. CSLI Press, 2000.
- [13] M. Marcus, D. Hindle, and M. Fleck. D-theory: Talking about talking about trees. In *Proceedings of the 21st Annual Meeting of the Association for Computational Linguistics*, pages 129–136, 1983.
- [14] R. Muskens. Talking about trees and truth-conditions. *Journal of Logic, Language and Information*, 10(4):417–455, 2001.
- [15] G. Perrier. Interaction grammars. In *Proceedings of the International Conference on Computational Linguistics (COLING)*, 2000.
- [16] J. Pustejovsky. The generative lexicon. *Computational Linguistics*, 17(4):209–441, 1991.
- [17] O. Rambow and K. Vijay-Shanker. D-tree grammars. In *Proceedings of the 33rd Annual Conference of the ACL*, 1995.
- [18] U. Reyle. Dealing with ambiguities by underspecification: Construction, representation and deduction. *Journal of Semantics*, 10(2):123–179, 1993.
- [19] A. Rossdeutsch U. Reyle and H. Kamp. Ups and downs in the theory of temporal reference. submitted to *Linguistics and Philosophy*, 2004.
- [20] N. van Leusen and R. Muskens. Construction by description in discourse representation. In J. Peregrin, editor, *Meaning: The Dynamic Turn*, pages 33–65. 2003.