

## RESEARCH ARTICLE

# Taking a goal-centred dynamic snapshot as a possibility for local homing in initially naïve bumblebees

Anne Lobecke\*, Roland Kern and Martin Egelhaaf

## ABSTRACT

It is essential for central place foragers, such as bumblebees, to return reliably to their nest. Bumblebees, leaving their inconspicuous nest hole for the first time need to gather and learn sufficient information about their surroundings to allow them to return to their nest at the end of their trip, instead of just flying away to forage. Therefore, we assume an intrinsic learning programme that manifests itself in the flight structure immediately after leaving the nest for the first time. In this study, we recorded and analysed the first outbound flight of individually marked naïve bumblebees in an indoor environment. We found characteristic loop-like features in the flight pattern that appear to be necessary for the bees to acquire environmental information and might be relevant for finding the nest hole after a foraging trip. Despite common features in their spatio-temporal organisation, first departure flights from the nest are characterised by a high level of variability in their loop-like flight structure across animals. Changes in turn direction of body orientation, for example, are distributed evenly across the entire area used for the flights without any systematic relationship to the nest location. By considering the common flight motifs and this variability, we came to the hypothesis that a kind of dynamic snapshot is taken during the early phase of departure flights centred at the nest location. The quality of this snapshot is hypothesised to be 'tested' during the later phases of the departure flights concerning its usefulness for local homing.

**KEY WORDS:** Bumblebees, Learning flight, Intrinsic programme, Behavioural diversity, Local homing

## INTRODUCTION

The necessity of finding a route between the nest and a feeding site characterises a bumblebee's everyday life as well as that of other hymenopterans. Bumblebees hatch inside their nest. When they leave it to forage for the first time, they are completely naïve and unfamiliar with its surroundings. In contrast to the hive of commercially bred honeybees, which is often coloured, the nest holes of bumblebees are inconspicuous and hard to find for humans, which makes it even more impressive that bumblebees find the nest entrance after returning from a foraging trip. To accomplish this challenging task, the insect is required to gather sufficient information about the surroundings of the nest hole, suggesting an intrinsic learning programme. This learning programme should manifest itself in the flight structure of the departure flights

immediately after leaving the nest for the first time. However, such a programme cannot be expected to be entirely static and stereotyped, as it needs to be adjusted somehow to the specific environmental situation. This situation is unpredictable for the bee when leaving the nest hole for the first time and may differ a lot, for instance, when the nest entrance is oriented horizontally or vertically, or the vegetation next to it is tightly cluttered or, alternatively, only loosely scattered. The learning programme might also differ in detail between individual bumblebees from the same hive. However, common flight characteristics, which help all individuals gathering information, should be detectable by analysing the flights.

Characteristic flight patterns, commonly interpreted as learning flights, have been observed in bees and wasps when they are unfamiliar with the surroundings of a relevant place. They then perform peculiar flight sequences after leaving this place, which have been concluded to help the gathering of visual information about the environment near this place. Previous studies describe such learning flights as distinct and relatively stereotyped movement patterns with several common flight motifs. Flight manoeuvres of increasing arcs are characteristic for social wasps (Collett and Lehrer, 1993; Stürzl et al., 2016; Zeil, 1993). Thereby, the insects continually gain height and turn in such a way towards a pivoting point that they keep the retinal image of the goal in the ventral part of the fronto-lateral visual field (Collett and Zeil, 1996; Zeil et al., 2007, 2009). Similar flight patterns were also described for honeybees when leaving a profitable food source. Most of these departure flights contain a high amount of translational movement and a backing away from the target structure, while facing it for a large proportion of time (Braun et al., 2010; Dittmar et al., 2010; Lehrer and Collett, 1994). This behaviour, often termed turn-back-and-look behaviour, was first described by Lehrer (1991, 1993) for honeybees as part of an efficient navigation system. Bumblebee departure flights from their nest hole show a loop-like structure, which differs from the arcing pattern of social wasps and honeybees (Philippides et al., 2013). Bumblebees, rather than performing a turn-back-and-look behaviour, make small excursions away from the nest and then fly back towards the nest region and look at it (Collett et al., 2013; Hempel de Ibarra et al., 2009; Philippides et al., 2013). These movement patterns might be part of an efficient navigation system in bumblebees that allows the insects to gather, learn and later retrieve the information in the vicinity of their nest relevant for finding the way back to it.

Navigation in hymenopterans takes place on a wide range of spatial scales (Collett and Collett, 2002; Wolf, 2011). Insects determine the direction to the goal (e.g. by using the sun compass) and the length of the segments of locomotion during large-scale navigation (within hundreds of metres or even kilometres). The length of the segments of locomotion might be provided by visual odometry in flying insects or by counting steps in ants (Collett and Collett, 2002; Collett et al., 2006b; Wittlinger et al., 2006; Wolf, 2011). However, route finding during large-scale navigation may

Department of Neurobiology and Cluster of Excellence 'Cognitive Interaction Technology' (CITEC), Bielefeld University, 33615 Bielefeld, Germany.

\*Author for correspondence (anne.lobecke@uni-bielefeld.de)

 A.L., 0000-0002-0891-1429

Received 21 August 2017; Accepted 13 November 2017

also be based, depending on the habitat and species, on other visual information, such as characteristic views along the different routes to the goal location (Collett et al., 2003; Freas et al., 2017; Narendra et al., 2013; Osborne et al., 2013; Towne et al., 2017; Woodgate et al., 2016).

Small-scale navigation or local homing of hymenopterans is assumed to rely mainly on visual cues, such as the spatial constellation of conspicuous objects close to the goal or the skyline of the panorama surrounding it (e.g. Buehlmann et al., 2016; Collett and Collett, 2002; Collett et al., 2006a,b; Freas et al., 2017; Towne et al., 2017; Zeil et al., 2009). Another visual cue exploited is optic flow: as stereopsis is not feasible for insects in the spatial range relevant for local homing, they rely largely on visual information from retinal image displacements generated by their structured movements (Dittmar et al., 2010; Egelhaaf, 2009; Egelhaaf et al., 2012; Gibson, 1950, 1979; Srinivasan, 1993). Translational movement causes close target structures, such as the nest hole at departure and objects close to it, to shift further across the retina than objects further away (Stürzl and Zeil, 2007), which provides the insect with depth information (Lehrer and Collett, 1994). The location of the nest hole in relation to surrounding environmental features, such as vegetation, might, thus, be gathered and memorised in this way (Dittmar et al., 2010; Zeil and Wittmann, 1993).

Despite all of these studies, the flight manoeuvres that are essential to find a way back to a specific place are not yet entirely clear. Furthermore, it is still an open question whether the insects learn during the entire first departure flight or only during specific parts of it; for example, when passing the place primarily in translational movement or at the end of an arc. Here, we address these still unresolved problems by analysing the spatio-temporal characteristics of departure flights of naïve bumblebees (*Bombus terrestris*) after they leave their nest for the first time. Considering that returning safely and quickly to the nest is essential for bumblebees, our analysis will rest on the assumption that learning behaviour is the outcome of dynamic interactions between innate behavioural learning routines and visual information about the environment, which is actively shaped by just this behaviour as a consequence of the closed action–perception loop. The intrinsic learning programme is expected to manifest itself, at least in a given environment, by a flight strategy with clearly invariant behavioural motifs. Therefore, we searched for invariants across animals in the spatio-temporal characteristics of the flight pattern that allow us to pinpoint the intrinsic behavioural programme.

Several studies on local homing concentrated on the organisation of departure flights of bumblebees in semi-natural settings (Collett et al., 2013; Hempel de Ibarra et al., 2009; Philippides et al., 2013; Riabinina et al., 2014). As the rich environmental information in such environments can hardly be controlled by the experimenter, we carried out our analysis under laboratory conditions, where the environment is controlled by the experimenter. This indoor setting also implicates that the experimental set-up is restricted in space. Our analyses, thus, focus on small-scale navigation, i.e. on how the animals localise their inconspicuous nest hole when they are already close to it. Complementary studies concentrated on large-scale navigation in honeybees and bumblebees by using radar techniques and analysed, on a much larger but coarser spatial scale, how the animals manage to get to the vicinity of their nest (Capaldi and Dyer, 1999; Capaldi et al., 2000; Osborne et al., 2013; Woodgate et al., 2016). Our analyses focus explicitly on small-scale navigation in a local-homing task. For the first time, we recorded, in a

systematic way, consecutive sequences of outbound and inbound flights of individually marked bumblebees that have been initially naïve regarding the visual environment of their nest entrance, allowing us to analyse the process and ontogeny of learning. In contrast to several other studies investigating bumblebee flight trajectories (Collett et al., 2013; Hempel de Ibarra et al., 2009; Philippides et al., 2013; Riabinina et al., 2014), we used two high-speed cameras instead of one to get three-dimensional (3D) data. On this basis, we could reconstruct flight organisation in 3D. The present study is the first of a series that analysed the entire progression of learning and the consequences for the spatio-temporal organisation of successful return flights to the nest after foraging trips. We conclude the analysed flights to be successful departure flights during which the bumblebees learn sufficient information about their environment, because most of the flights were followed by a return flight that ended at the nest hole connected to the hive (A.L., R.K. and M.E. in preparation). In this first paper of the series, we focus on the very first outbound flights of bumblebees that are entirely naïve regarding the specific environment in which they forage and attempt to answer the following questions: in which way is the intrinsic behavioural programme affected by the specific spatial layout of the surroundings of the nest entrance? How stereotyped is the innate learning strategy and how variable and inter-individually different may the behaviour be while still ensuring homing success?

## MATERIALS AND METHODS

### Animals and experimental set-up

We obtained commercial bumblebee hives of *Bombus terrestris* (Linnaeus), containing only a few individuals, from Koppert (Berkel en Rodenrijs, The Netherlands). The beehive was kept within a cubic Perspex box (each side measuring 30 cm) covered with black cloth in a room with a 12 h:12 h light:dark cycle. A Perspex tunnel connected the nest box to another box of the same size, where the animals were free to fly and had access to an artificial feeder. On the first day after their arrival, the bees had the possibility to learn how to use the artificial feeder filled with a commercial sucrose solution from Koppert, which was one of five feeders used later in the experiments. After one or two days, the feeder was removed for most of the time and only returned to prevent the animals from starving during phases where no experiments were performed. The bumblebees had access to pollen, put directly into the nest box, *ad libitum*. Another tunnel section from the Perspex tunnel between the boxes led the bumblebees to a PVC tube (inner diameter 20 mm) connected to a hole in the floor of the test arena (Fig. 1A).

The behavioural analysis was performed in an octagonal test arena with an inner diameter of 95 cm, which was placed on a table (Fig. 1A). Each wall segment was 60 cm high and 40 cm wide. The floor of the arena was covered with a red artificial grass carpet (Kunstgras Wereld, Antwerpen, Belgium) to add structure to the ground but no distinct cues, ensuring a stable flight performance by the bumblebees. Eight holes (3 cm in diameter) were drilled into the arena floor, each placed orthogonally to one of the wall segments at a distance of 22 cm (Fig. 1B). Throughout the different experiments, only one of the eight holes was connected to the nest. The bumblebees could enter the arena via the PVC tube and started their flights from the nest hole connected. Two white cylinders were placed 10 cm from that hole to indicate its connection to the nest. Apart from these cylinders, the nest hole could not be distinguished visually from the other holes. Regarding the holes in the floor, the arena was symmetrical and provided an

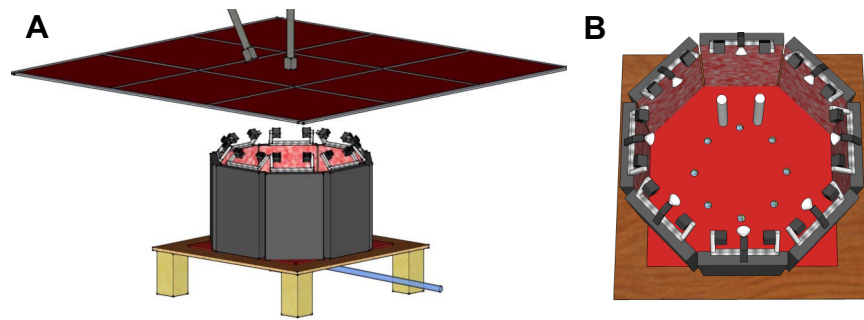

**Fig. 1. Experimental set-up.** (A) Flight arena seen from the side. Red acrylic glass plate construction above the table with the flight arena. Grey structures above the glass plate construction are the high-speed cameras. (B) Top view into the flight arena with eight holes, two cylinders next to the hole connected to the nest; the other holes were closed a few centimetres below the arena floor. The light set-up consisted of 16 red LEDs (indicated by the grey boxes close to the left and right of each panel of the octagonal arena wall) and eight white LEDs (indicated in white in the centre of each arena panel). The LEDs were mounted on the upper edges of the arena walls.

ambiguous situation for the experiments. A red acrylic glass plate, 3 m×3 m, was mounted 40 cm above the arena (Fig. 1A). Only light between 650 and 800 nm could pass through the acrylic glass. Therefore, the bumblebees, able to see light only up to 640 nm (Skorupski et al., 2007), were prevented from seeing the ceiling of the room and the cameras, which were placed above the glass plate (Fig. 1A). Eight white and 16 red LED lamps were positioned symmetrically with respect to the arena centre on top of its walls to provide sufficient light for the camera recordings (Fig. 1B). The luminance at the bottom of the arena varied between 100 and 200  $\text{cd m}^{-2}$ .

The bumblebees could leave the octagonal test arena and go into a large indoor flight room via the 40 cm gap between the arena walls and the acrylic glass plate. Bumblebees had access to feeders placed on a table in a corner of the flight room. The bees could forage at those feeders, which provided commercial sugar solution, and fly back to the hive. This ready-made solution was mixed with water at a ratio of 3:1.

Beige curtains separated the flight area containing the test arena from the rest of the room. Ten fluorescent lamps (Biolum 965, Osram, München, Germany) illuminated the room ( $55\text{--}100 \text{ cd m}^{-2}$ ). We used Biolum (Osram) light with a spectrum between 400 and 700 nm to create as natural spectral lighting conditions as possible.

### Recording procedure

Bumblebees could be separated by removable doors in the tunnel system, so that only one bee at a time could enter the flight arena. Their outbound and inbound flights were recorded with two high-speed cameras. These cameras (Falcon2 4M, Teledyne DALSA, Inc., Waterloo, Canada) were placed above the acrylic glass plate (Fig. 1A) and recorded the flights of the bumblebees at  $148 \text{ frames s}^{-1}$ , with an exposure time of  $1/1000 \text{ s}$  and a spatial resolution of  $2048 \times 2048$  pixels. The optical axis of the top camera pointed straight down. The optical axis of the second camera was 45 deg to the vertical. We recorded continuously for several hours on a hard disk array using the software Marathon Pro (GS Vitec, Bad Soden, Salmünster, Germany). Relevant sequences of outbound and inbound flights were stored as 8-bit jpeg images for the flight analyses. Sequences without relevant flights, i.e. where bumblebees just cross the recording area between the upper walls and the acrylic glass plate construction, were discarded. A webcam (AXIS M10 Network Camera, Axis Communications, Lund, Sweden) was placed above the feeding table to monitor whether bumblebees were foraging during the experiments.

### Training and test procedure

The bumblebees entered the test arena through one of the nest holes in the arena floor. Only one of eight nest holes was connected to the nest during the experiments. We started the recordings immediately we detected the bumblebee at the nest hole. During the training procedure, the two cylinders were placed next to the hole, which was connected to the nest and their positions were not changed during the first departing and return flights of each bee recorded. Bumblebees were able to forage at the feeding table during their flights in the flight room. After stopping a recording session at the end of one day, the end of the PVC tube leading to the arena was cleaned with 70% ethanol to remove potential odour cues placed by the bees. The space available for the bumblebees' outbound and inbound flights was restricted in such an arena. As an advantage of this restricted space, the bumblebees were forced to do the major part of their departure flights in an area that is entirely viewed by the cameras. Consequently, the flights recorded contain no gaps provoked by an open space set-up, i.e. when the bumblebees were not restricted by any walls and could leave the recording area during the first seconds of the flight. Nevertheless, the flight structure obtained under these conditions does not differ in any obvious way from the departure flights obtained in other studies under different environmental conditions (Collett et al., 2013; Hempel de Ibarra et al., 2009; Philippides et al., 2013; Riabinina et al., 2014).

### Data analysis

The image sequences from both cameras were analysed with the custom-built software ivTrace (Lindemann, 2005; <https://opensource.cit-ec.de/projects/ivtools>), where the position of the bee and the orientation of its body-length axis were determined automatically. Additionally, ivTrace calculated the body orientation (yaw angle) from the top camera images. In some cases, ivTrace had problems in tracking the elliptical form of the bumblebee's body, and the yaw angle could not be determined automatically. This could happen when a bee crossed one of the nest holes or one of the edges between the arena wall segments. Then, the software could only partially distinguish the bee from the dark background. In cases in which the automatic tracking procedure failed, the body position of the bee and the orientation of its body-length axis were determined manually. The Camera Calibration Toolbox for MATLAB (Bouquet, 1999) was used for the camera calibration and the 3D stereo triangulation. A checkerboard pattern (5 cm per square) was used for the calibration. We determined the difference between recordings by



the camera and the calculation. The average position error for the top and the side camera was 0.11 and 0.09 pixels, respectively. The time series of body orientation angles of the bees was filtered using a Gaussian filter with a window length of 1.35 ms for some aspects of the analyses. In addition to the yaw angle of the bees' body orientation, several other parameters, for example, height over ground and retinal position of the nest hole, were analysed and compared to characterise the spatio-temporal structure of the flights.

The analysis is based on 21 first departure flights of 21 initially naïve bees with a total duration of 835 s. The three trajectories shown in Fig. 2 are selected samples aimed to visualise the range of variability of the first flight across bumblebees.

## RESULTS

This study is based on the assumption that the spatio-temporal organisation of outbound flights of bumblebees after leaving the nest hole for the first time is the outcome of dynamic interactions between innate behavioural learning routines and visual information about the environment. This information is actively shaped by the innate behaviour due to the closed action–perception loop. The astonishing feat that a single departure flight in an unpredictable environment is sufficient for the initially naïve insects to return to their home location is worth investigating in a systematic way. That bumblebees and other hymenopterans gather relevant information about the environment on their departure flights from their nests is plausible as they perform peculiar flight sequences, and the departure flights decrease in duration and complexity with experience (Lehrer, 1991, 1993).

Here, we analyse for the first time systematically what is special about the structure of the first departure flight of naïve bumblebees, inter-individually and compared with other flying hymenopterans. Are there invariant motifs in the flight manoeuvres that might be necessary for learning the location of the nest hole? We took a closer look at the flight structure of initially naïve bumblebees in an indoor test arena to find this out.

### Description of the overall flight structure

We observed a broadly similar flight pattern in bumblebees as described for social wasps and honeybees (cf. Introduction): the flights, starting from the nest hole, increased in height and distance to the starting point over time, as shown for three example flights in Fig. 2. In contrast to the arcs of social wasps and the backing away from the nest hole of honeybees, the bumblebees performed loop-like excursions away from the nest and then flew back towards the nest region, a performance that is reflected in fluctuations of flight height and distance to the nest hole (Fig. 3). This flight characteristic and particularly the characteristic variations in distance to the nest appear to be in accordance with what has been described for bumblebees under outdoor conditions, although these studies did not monitor the height of the animals (Collett et al., 2013; Hempel de Ibarra et al., 2009; Philippides et al., 2013; Riabinina et al., 2014). Bumblebees faced towards the nest region in large parts of the loops (Fig. 4), as do wasps and honeybees for most of the time during the initial sections of their departure flights from the nest hole (Collett and Lehrer, 1993; Stürzl et al., 2016; Zeil, 1993).

After spending some time close to the nest hole, the bumblebees extended their departure flights towards the centre of the arena, where more space is available for their flights. The area between the nest hole and the closest arena wall was mostly avoided by the bumblebees. This suggests that they familiarise themselves with the

immediate surroundings of the nest hole during this early part of the flight and take information about the spatial layout of the environment into account in shaping their flights. The bumblebees flew close to the ground most of the time during this initial flight section, with an altitude roughly below 100 mm. After some time, they increased height and distance to the nest hole in loop-like flight patterns covering large parts of the horizontal extent of the flight arena, including the nest hole region. When the bumblebees reached the height of the cylinders' upper edge at 400 mm, they mostly circled around at this altitude, using the entire arena space.

These observations and previous studies suggest that the learning of the nest hole location and its immediate environment occurs during the initial phase of the departure flights. Therefore, we decided to divide the flights into three different phases.

Phase 1 represents the flight sections below 100 mm above ground level of the arena. This phase may include fluctuations in altitude where the bee's altitude exceeds 100 mm but then returns to an altitude of less than 100 mm.

Phase 2 includes the flight sections between 100 and 400 mm altitude, excluding the flight sections where altitudes exceeded 100 mm (contained in phase 1) and including brief flight sections where the bee's altitude exceeds 400 mm but then returns to an altitude of less than 400 mm.

Phase 3 contains flight sections exceeding 400 mm altitude, i.e. 400–800 mm. Fluctuations that belong to phase 2 were excluded. Flight manoeuvres above a height of 800 mm were excluded from the analyses.

The exact height thresholds defining the three flight phases do not represent altitudes that correspond to any marked changes in flight style and might, to some extent, be arbitrary. Rather, the transitions between flight phases appear to be somehow smooth. However, we ensured that the conclusions we will draw from our experiments are independent of the specific classification into the three flight phases.

### Leaving direction from the nest hole

When bumblebees leave their nest hole for the first time, they do not know anything about its specific surroundings. This means that they cannot know in which direction to head for their search for potential feeding sites. Accordingly, the direction of the first departure from the nest hole should be arbitrary, unless the tube leading the bee to the nest hole was in some way asymmetric. Therefore, we analysed whether potential tube asymmetries affected the leaving direction of bees from the nest hole. This was done by subdividing the arena floor around the nest hole into eight 45 deg segments and counting the bees entering each segment after leaving the nest hole. The number of 21 initial departure flights available did not allow for a finer segment size as a basis for statistical testing. Only the segment entered first was counted, independent of the segment where the bumblebee started its flight. A  $\chi^2$  test showed no significant deviation from a uniform distribution at a significance level of  $P=0.05$  and, thus, no evidence that the tube properties influence the bumblebees' direction of departure in any strong way. A similar result was obtained for the direction of take-off around the nest location ( $\chi^2$  test,  $P=0.05$  significance level). These results suggest that the asymmetry in the flight pattern of the population of outbound flights (see next paragraph) is largely independent of the asymmetries in the tube system that leads the bees to the nest hole. Accordingly, the asymmetry in the overall flight pattern of all bees tested was probably caused by the spatial layout of the test arena (i.e. location of cylinders and walls of the arena).

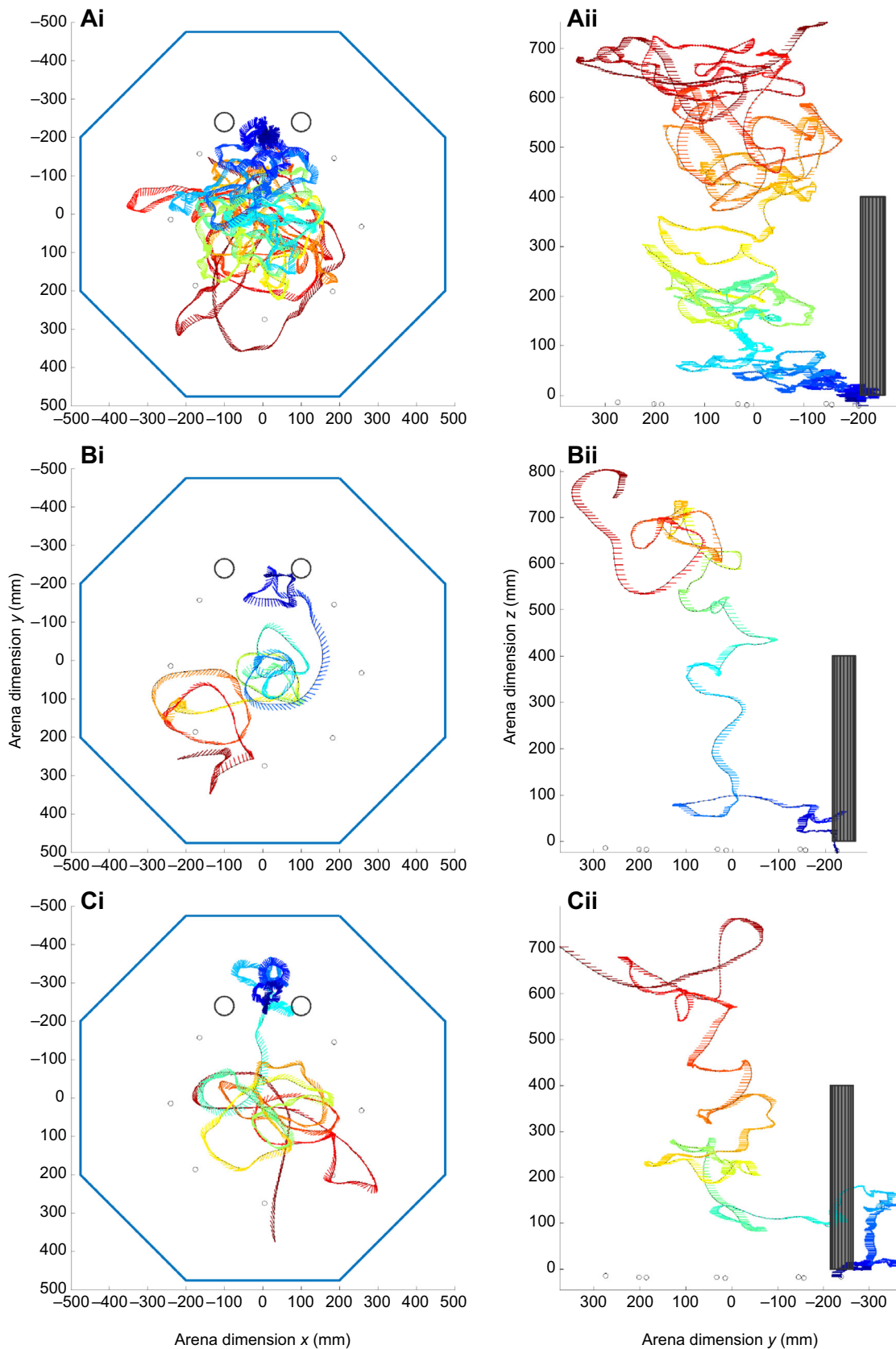

**Fig. 2.** Flight trajectories of the first flights of three different bumblebees seen from above and from one side. Three example trajectories out of the 21 first departure flights analysed. Grey circles in the top view (Ai–Ci) and grey rectangles in the side view (Aii–Cii) indicate cylinders; coloured lines indicate the orientation of the bee's body-length axis every 20.27 ms; end of lines marks head position; and sequence of head positions defines trajectory. Trajectories are colour coded with time: dark blue indicates beginning of flight and dark red indicates end of flight. Axes scales are given in mm. Coordinates '0.0' represent the centre of the flight arena.

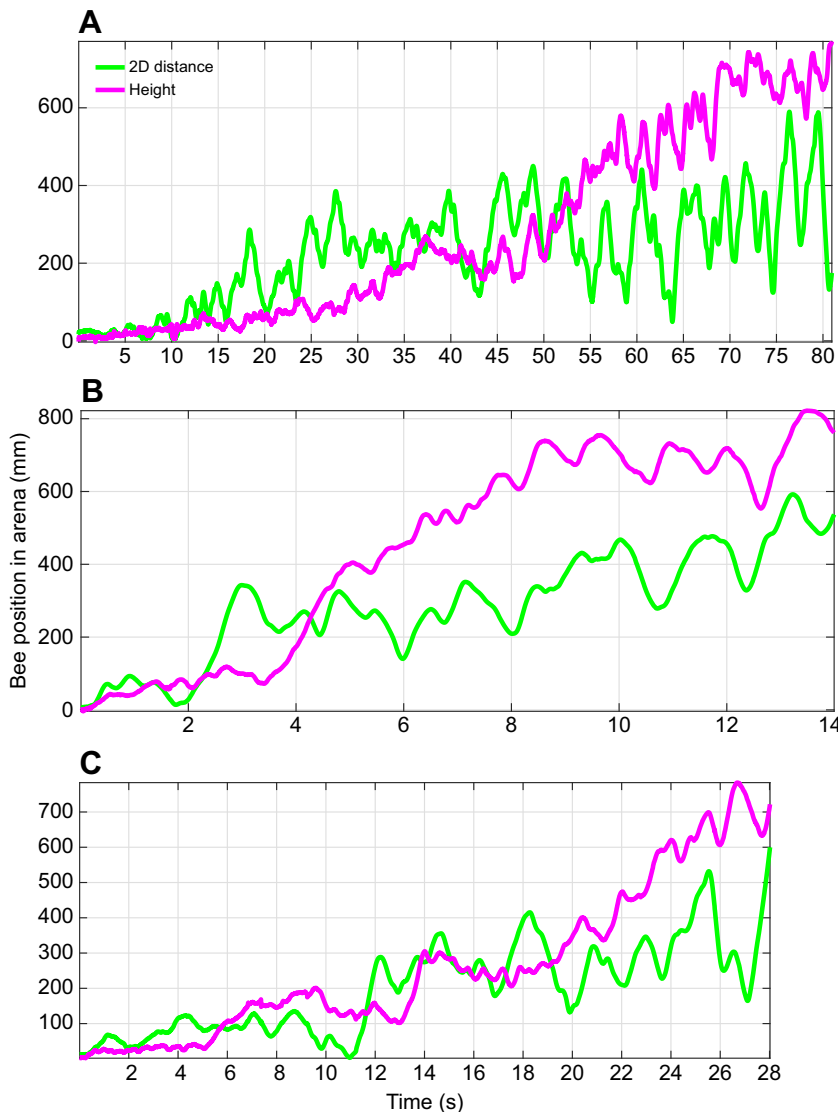

**Fig. 3. Time course of altitude and distance to the nest hole.** Data are shown for initial segments of the same three departure flights as shown in Fig. 2.

### Asymmetry of flight around nest hole

The bumblebees were confronted with an initially unpredictable environmental situation in our experimental set-up, including unequal distances to the eight wall segments of the arena and the two cylinders, which we positioned next to the nest hole. As long as the bees did not consider any environmental information when shaping their flights, the overall distribution of flight paths across bumblebees should be symmetrical around the nest hole, because they do not have any reason to prefer one direction, although individual flights might be asymmetric just by chance. Hence, as soon as asymmetries in the overall flight patterns across flights can be detected, spatial information about the surroundings of the nest hole is used by the bees to organise their flights. The bumblebees' flights shifted towards the centre of the arena after an initial flight phase close to the nest hole, as Figs 2 and 4 illustrate. We scrutinised the flight trajectories in two ways to find out when after flight onset spatial information is employed by the bees: we first divided the arena conceptually by a horizontal line crossing the nest hole to test whether the closest wall influenced the shape of the bumblebees' flights. This line served as a symmetry line for the flight pattern. The range closer to the wall was defined as range 1 and the one towards the centre of the arena as range 2 (Fig. 5A).

We expected the bees to spend more time of their flight in range 2, which is the direction to the centre of the arena where more space is available. The time point when the bees started spending more time in range 2 rather than in range 1 is interpreted as the time point when the spatial layout of the arena plays a role in shaping the flights. On average, the bumblebees never tended to spend more time (over 50%) of their flights in range 1 rather than in range 2. After 7 s of the flight, they spent an average of more than 75% of their flight in range 2, the direction to the centre of the arena (Fig. 5B). A binomial test showed a significant deviation from a uniform distribution ( $P=0.001$ ).

We carried out further experiments to test directly whether this shift of the flight trajectories towards the centre of the arena is a consequence of the unequal distances to the eight wall segments. In these experiments, we closed all eight peripheral nest holes and opened one nest hole in the centre of the arena, so that all wall segments were at the same distance to the nest hole and the flight structure should not depend on the arena architecture. Now, both ranges covered the same size of the arena: range 1 was above the horizontal line crossing the nest hole in the centre, while range 2 was beneath it. Although individual flights observed under this condition ( $N=8$ ) were still asymmetrical and tended to cover one

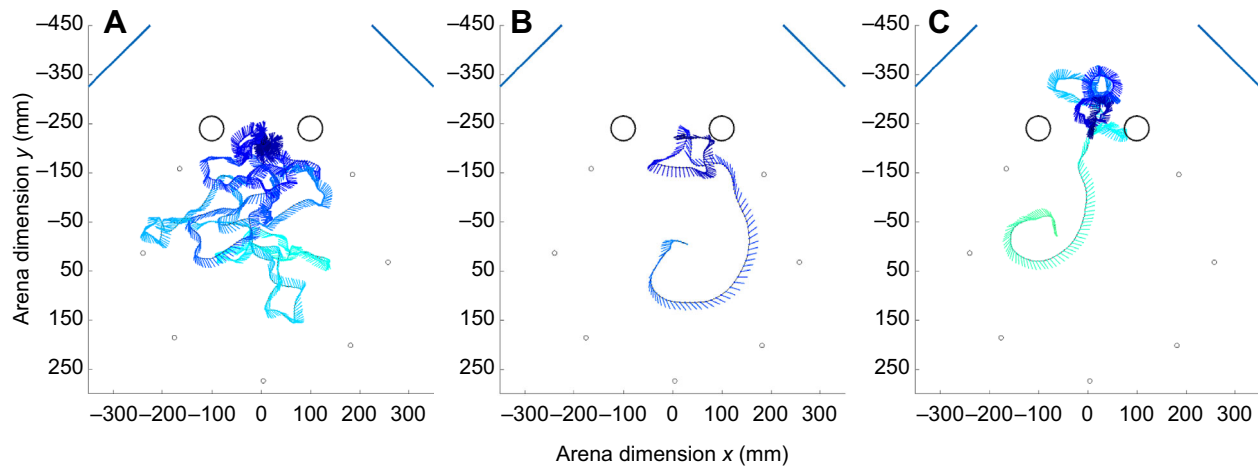

**Fig. 4. First phase of departure flights.** Top view of initial segments of the same three departure flights as shown in Fig. 2 for flight height above ground below 100 mm (seen from above). Coloured lines show the orientation of the bee's body-length axis every 20.27 ms; end of lines marks head position; and sequence of head positions defines trajectory. Flight trajectories colour coded with time as in Fig. 2. The flight examples show many segments of translational movement.

range of the arena, the outbound flights generally showed no preference of one range over the other (data not shown, binomial test,  $P=0.05$ ). Another observation during these control experiments was that individual bees, after they started flying into a given range of the arena, stuck to it until they reached the height of the cylinders (400 mm), and then tended to use the whole arena for the last flight phase before leaving the arena. However, both ranges were chosen with the same likelihood across bees.

We used the same flight data to test whether and after what time interval the two cylinders close to the nest hole shaped the flight trajectories. Two conceptually perpendicular lines across the arena divided the space into four segments, of which two include a cylinder (Fig. 6A). The analyses showed that the bumblebees avoided the segments containing the cylinders during most of their flight time (over 50%). They spent an average of more than 75% of their flight time in range 2 after 8 s (Fig. 6B). A binomial test showed a significant deviation from a uniform distribution ( $P=0.001$ ). These results, thus, reveal that after leaving the nest for the first time, the innate learning routines of bumblebees are

modified immediately or, at the latest, after a few seconds, by spatial information about the specific surroundings, probably extracted from the retinal image changes actively generated by the behavioural routines.

#### Turn-back-and-look behaviour – retinal position of the nest hole

Honeybees perform a so-called turn-back-and-look behaviour, where the bees turn around immediately after leaving the hive and face its entrance during the initial sections of the departure flight (Lehrer, 1991, 1993). Similarly, social wasps keep the retinal image of the target in the ventral part of the fronto-lateral visual field during the initial phase of departure flights (Collett and Lehrer, 1993; Collett and Zeil, 1996; Zeil et al., 2007, 2009). Nevertheless, fixation of the nest hole has been reported to be rather inaccurate, because the image of the nest hole is kept within a rather extended retinal area after the insect has gained distance from the nest (Zeil, 1993). These studies suggest that it might be useful, if not essential, for hymenopterans to look with the frontal part of their visual field at

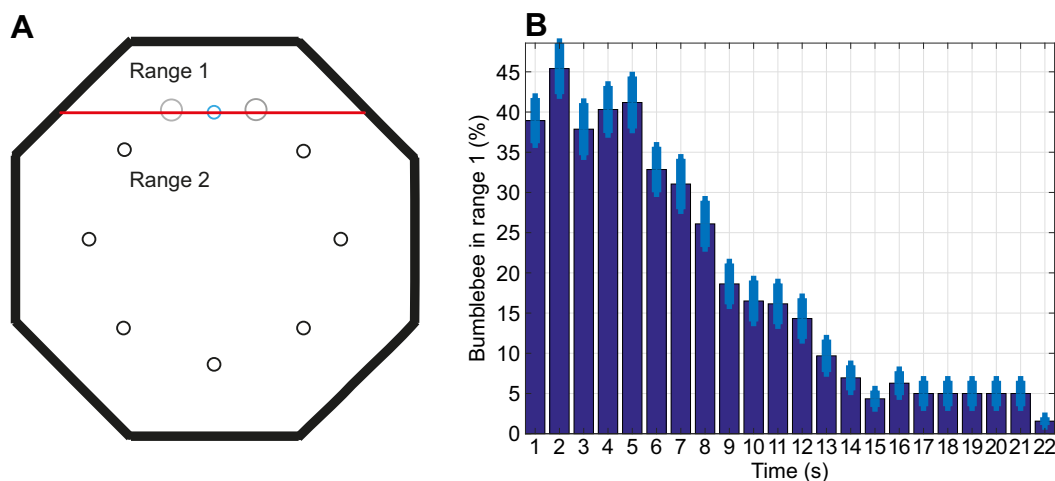

**Fig. 5. Asymmetry of flight around nest hole.** (A) Arena divided into range 1 and range 2 (red line). Black circles, 'dummy' nest holes; blue circle, connected nest hole; grey circles, cylinders. (B) Percentage of time bumblebees spent in range 1 as defined in A as a function of time. For this analysis, time was binned in 1 s intervals. Dark blue bars indicate mean across bees whereas light blue bars indicate standard deviation.  $N=21$  first departure flights.

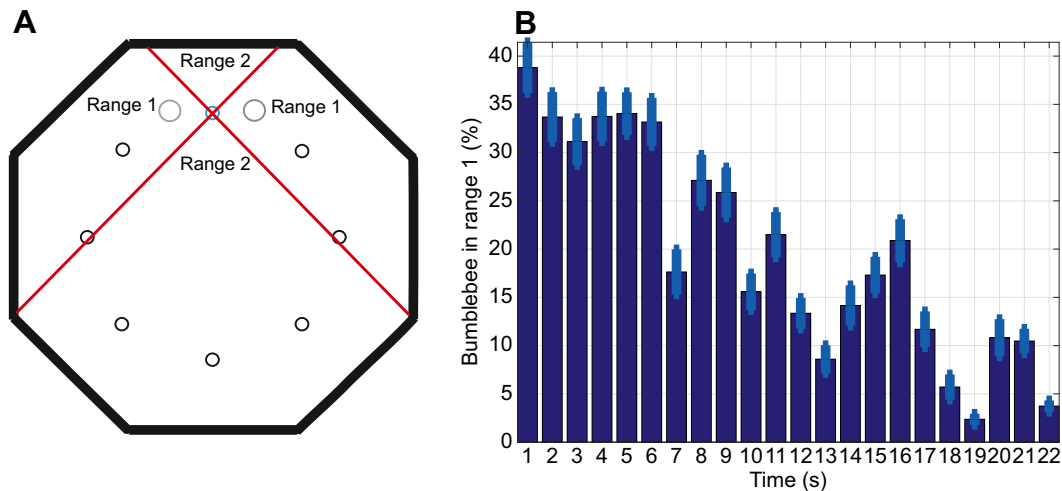

**Fig. 6. Asymmetry of flight around nest hole in respect to cylinders.** (A) Arena divided into ranges 1 and ranges 2 (red lines). Black circles, 'dummy' nest holes; blue circle, connected nest hole; grey circles, cylinders. (B) Percentage of time bumblebees spent in range 1 as defined in A as a function of time. For this analysis, time was binned in 1 s intervals. Dark blue bars indicate mean across bees whereas light blue bars indicate standard deviation.  $N=21$  first departure flights.

the nest hole and its surroundings at least in the initial sections of the first outbound flight.

A histogram of the retinal nest hole position was determined to assess whether this also holds for bumblebees, i.e. whether they keep the retinal image of the nest hole in a specific range of the visual field during significant parts of the initial phase of the outbound flights. Fig. 7A shows that the nest hole is kept broadly in the frontal visual field between  $-60$  deg and  $+60$  deg across the bees tested for most of the time. However, there seems to be no distinct region of the eye where the bumblebees fixated their nest hole. Rather, bees tended to look roughly towards the nest hole and its neighbouring regions for most of the time during the initial phase of outbound flights. This characteristic does not hold if bees gained height during the subsequent flight phases. A  $\chi^2$  test in phase 2 (significance level of  $P=0.05$ ) showed no significant deviation from a uniform distribution (Fig. 7B). Furthermore, the retinal image of the nest hole was in the rear part of the eye for more time than it was in the frontal visual field in phase 3 (Fig. 7C). This might be a consequence of the structure of flight trajectories in the octagonal arena: bumblebees used more space of the arena and tended to fly in increasing loops at higher altitudes. The time intervals where the bees face the nest hole region are, therefore, shorter than the time where the nest hole is seen roughly in the lateral regions and the rear part of the visual field. Furthermore, the nest hole might play a minor or no role at heights above 400 mm. Therefore, the corresponding data cannot be interpreted as an active looking away from the nest hole.

We had a closer look at the first sections of the outbound flights, as the fixation of the nest hole in a broad frontal retinal area plays a significant role in the initial phase. Zeil et al. (2009) observed that fixation periods in wasps occur during translations past the nest entrance, mostly during the arcs, where the wasps tend to pivot around the nest entrance (Boeddeker et al., 2010; Zeil et al., 2009). We looked for locations in the flight arena where the bumblebees kept the nest region in the frontal visual field between  $-25$  deg and  $+25$  deg to find out whether this is also a characteristic of bumblebees' first outbound flights. These locations are distributed throughout the whole area covered by the flight trajectories and do not correspond to distinct locations in the arena relative to the nest

hole (Fig. 8A–C). The duration of the flight sections when the bumblebees faced the nest region varies for the individual bees as well as across bees, and covers a broad range of time intervals (Fig. 8D). Durations between 0 and 65 ms might be explained by a full rotation or loop flown by the bumblebee where the nest location crossed the insect's retina inevitably between  $-25$  deg and  $25$  deg. The other large portion of data covers a range between 165 and 550 ms, and we conclude them to be fixations of the nest region in the frontal visual field. We found no systematic relationship between the locations of these fixations and the nest region: the flight sections where the bumblebees kept the nest hole between  $-25$  deg and  $25$  deg in their frontal visual field are distributed evenly across the entire area of the flights (Fig. 8E).

#### Sideward and forward components of flight

Flying insects, such as bees, perform a saccadic flight and gaze strategy to separate rapid head and body saccades from largely translational intersaccadic locomotion (Boeddeker et al., 2010, 2015; Braun et al., 2010, 2012; C. Doussout, O. J. N. Bertrand, R.K. and M.E., in preparation; Geurten et al., 2010; Schilstra and van Hateren, 1999). This strategy facilitates access to spatial information from the resulting optic flow (Egelhaaf et al., 2012), because only translational optic flow is distance dependent and contains spatial information.

A sequence of pure translational and pure rotational movements in one flight segment, therefore, might be expected for outbound flights of bumblebees as well. Although there are clear indications in our data for such a saccadic flight strategy (Fig. 9A), the spatial resolution of our video footage was not sufficient, given the chubby shape of bumblebees and the relatively large area that had to be filmed, to address the temporal fine structure of the bees' gaze strategy precisely at the level of body orientation and, especially, not at the level of head orientation. This issue will be tackled in detail in a forthcoming study (C. Doussout, O. J. N. Bertrand, R.K. and M.E., in preparation). Translational movements can be either forward/backward, sideward or a combination of both (diagonal) without changes in the yaw angle of the body orientation. We determined the proportion of either of these components of translational movements to characterise the overall flight



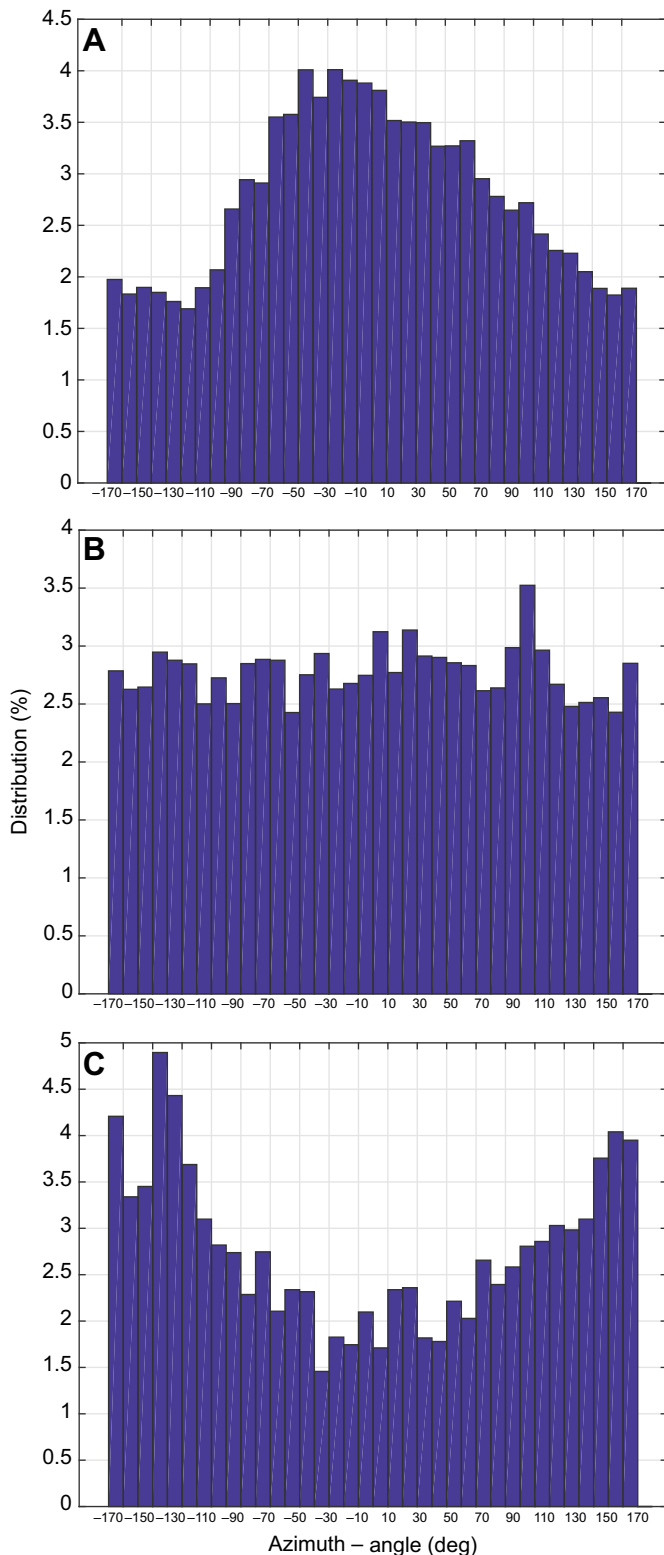

**Fig. 7. Histogram of the retinal nest hole position.** (A) Flight phase 1 (below a height of 100 mm): the nest hole is kept broadly in the frontal visual field between  $-60$  deg and  $+60$  deg across the bees tested for most of the time of a departure flight. (B) Flight phase 2 (height between 100 mm and 400 mm): no distinct region of the eye where the bumblebees fixated their nest hole. (C) Flight phase 3 (above a height of 400 mm): the retinal image of the nest hole was in the rear part of the eye for more time than it was in the frontal visual field; over 75% in  $-180$  deg to  $-60$  deg and  $60$  deg to  $180$  deg but less than 25% in the region between  $-60$  deg and  $+60$  deg. Red dashed lines indicate means of retinal position.  $N=21$  first departure flights.

spatial information in the lateral field. Sideward translational components predominated in the flight pattern in the first flight phase, while forward or backward movements were less prominent. This characteristic is specific for the initial phase of departure flights, as the proportion of sideward motion in later phases decreases over time and forward movements dominate the overall translatory flight component (Fig. 9B–D). Flight manoeuvres with large sideways translational components close to a goal location are also known for honeybees (Braun et al., 2012; Dittmar et al., 2010) and hoverflies (Geurten et al., 2010). These sideways movements can be used by the insects to extract relative motion cues to estimate their distance to targets, such as the nest hole, which seems to be relevant in the early learning phase (Dittmar et al., 2010). These observations suggest that the sideward components during the initial phase of departure flights of bumblebees might play a role in gathering depth information in the close vicinity of the nest hole.

#### Changes in turn direction (CTD) of the body

Not only translational movements but also rotational movements play a role in an insect's flight. Bumblebees perform loop-like excursions from and back to the nest hole during departure flights. Therefore, apart from translational flight sections, the flights show rotations of the bees' body-length axis (yaw rotations). The CTD might be particularly relevant, as they indicate decision points in flight behaviour. Such CTD for social wasps are generated at the end of the arcs characterising their departure flights and have been concluded to be elicited whenever the retinal image of the nest entrance moves to a lateral position in the visual field (Collett and Lehrer, 1993; Zeil, 1993; Zeil et al., 1996, 2007, 2009). The CTD, thus, lead to a correction of the accumulating retinal position error of the nest entrance (Zeil, 1993).

Inspired by these observations, we took a closer look at the CTD of body orientation of bumblebees. The bees' body orientation shows an alternating sequence of clockwise and counter-clockwise rotations (Fig. 10A). We analysed whether the reversals of turning direction are generated in specific spatial regions in the arena relative to the nest hole to get hints as to what environmental cues (i.e. the cylinders, the edges between arena walls or the nest hole itself) might trigger these changes. The locations where the bees perform CTD seem to be randomly distributed across the entire flight area during the initial phase of departure flights (Fig. 10B). Nevertheless, we observed a tendency for more clockwise CTD when the nest hole was on the right side of the bee and more counter-clockwise CTD when the nest hole was on the left side (Fig. 10Ci and Cii). This linking might reflect attempts by the bee to keep the nest hole region in the frontal visual field, performing a body rotation towards the nest when it leaves the fronto-lateral field. These attempts are performed in a similar, although not as precise, way as has been concluded for wasps (Zeil, 1993, 1996, 2007, 2009). This flight pattern disappears during later flight phases where the nest hole region might only play a minor or no role in shaping the flight (data not shown).

characteristic after leaving the nest hole and, especially, to what extent the bees performed sideward versus forward/backward movements. Flight sections where sideward components are prevalent are particularly relevant when spatial information is extracted from the retinal image flow in the frontal visual field, whereas forward or backward movement facilitates the extraction of

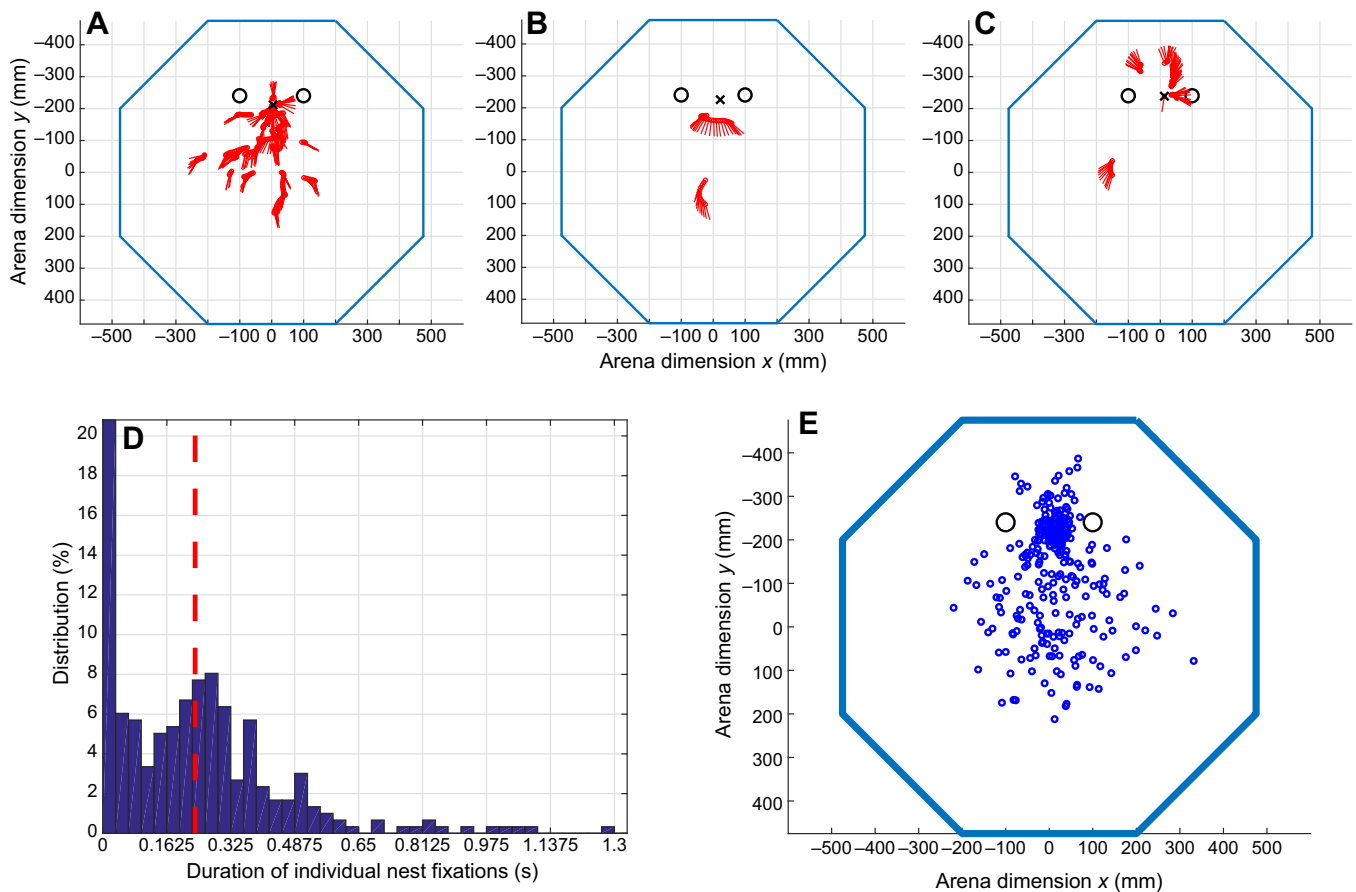

**Fig. 8. Locations in flight arena where bees fixate nest hole with frontal part of their visual field and duration of fixations.** (A–C) Locations and durations of nest fixations during first outbound flights (same as shown in Fig. 2). The position (red dots) and orientation (red lines) of the bumblebee in the arena when the nest hole is in the frontal visual field (between  $-25^\circ$  and  $+25^\circ$ ) is plotted. Time between consecutive dots is 20.27 ms. Crosses indicate the nest hole; circles indicate the cylinder; arena walls are shown in blue. (D) Duration of individual nest fixations in seconds for all bumblebees in flight phase 1 (below 100 mm).  $N=21$  first departure flights. (E) Locations in flight arena where bees fixate nest hole with frontal part of their visual field. Blue circles show the centre of each individual fixation section for all bumblebees in flight phase 1 (below 100 mm). Black circles indicate cylinders.  $N=21$  first departure flights.

Zeil (1993) described a surprisingly constant rate of the CTD for wasps. We observed an average period of 1.6 s for the overall flight for bumblebees. Furthermore, we did not find any specific differences in the frequency of CTD for the different flight phases. As the distance covered by the bee between CTD increased with altitude, the flight velocity during the turns increased accordingly (Fig. 10D). This shows that bumblebees in our experiments seemed to have a specific frequency range in which they performed the CTD. However, this range did not appear to be much affected by the bees' position in the arena. Rather, a CTD seemed to be initiated after a broadly constant time interval rather than a specific flight distance.

## DISCUSSION

Bumblebee foragers are confronted with unfamiliar and largely unpredictable surroundings of their nest hole on their first outbound trip. Therefore, they need to gather sufficient information about these surroundings before they leave the vicinity of the nest hole to be able to find it again after a foraging trip. This implies a kind of innate learning programme that controls, at least, the learning behaviour after a forager bee leaves the nest hole for the first time. The diversity of environments, however, makes it essential for the assumed innate learning programme to be flexible to adjust it to the specific surroundings.

Previous studies propose that insects take some kind of panoramic information from the target location after leaving their nest. What information about the environment is stored and recalled on the return flights is still, to a large extent, an open question, as there is evidence for a wide range of possibilities. Representations about the environment might be based on a panoramic retinotopic snapshot of brightness values (Kollmeier et al., 2007) or of local motion values ('motion snapshot'; Dittmar et al., 2010). It might also be based on a more parsimonious representation, such as the skyline of the horizon (Baddeley et al., 2011; Basten and Mallot, 2010; Graham and Cheng, 2009; Kollmeier et al., 2007; Philippides et al., 2011; Wystrach et al., 2011). The information stored at the goal location is assumed to be compared in an appropriate way with the corresponding environmental information taken during the return flights to the nest. One way to accomplish this is to determine the similarity of retinotopic representations of the environment and to move in a way that increases the similarity (Cartwright and Collett, 1987; Vardy and Möller, 2005; Zeil et al., 2009). Another possibility is not to store the information on a retinotopic basis but to determine an average landmark vector. The average landmark vector is just the sum of vectors representing, for instance, the average brightness across the elevation at each azimuthal position or of the vectors pointing to 'landmarks' identified in the retinal image. Landmarks might be simple environmental features, such as trees.

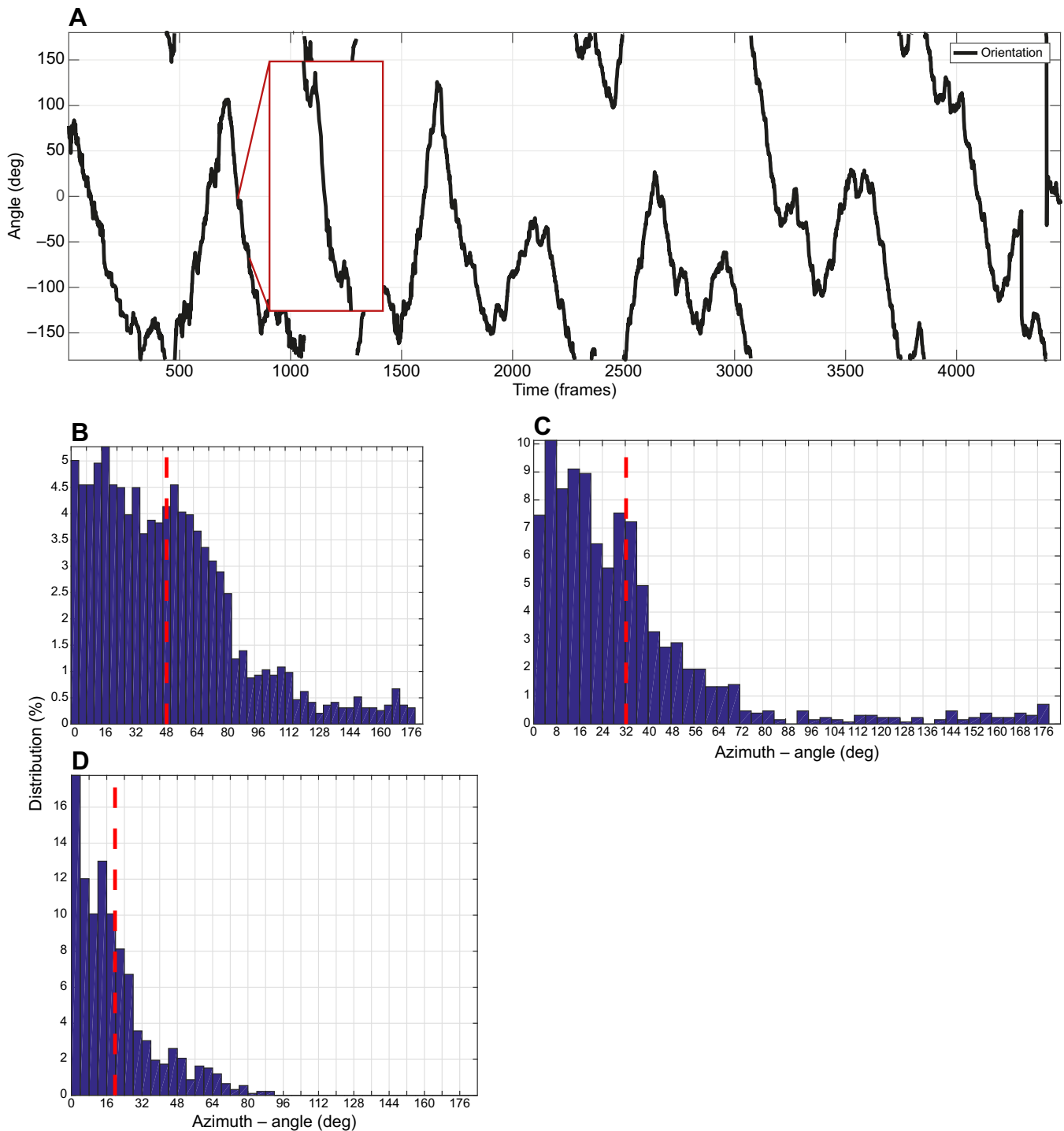

**Fig. 9. Saccadic flight structure.** (A) Time course of orientation of body-length axis of an example bumblebee on its first departure flight. The red rectangle shows an inset of the orientation to highlight the characteristic saccadic flight structure in an enlarged fashion. (B) Sideward and forward components of flight: distribution of direction of the translational component of motion relative to the orientation of the flight trajectory for all bumblebees for flight phase 1 (B), flight phase 2 (C) and flight phase 3 (D). The angle was determined from the ratio between the forward and sideward components of translation. The average angle is shown in red (dashed lines: 50 deg, 32 deg and 20 deg in B, C and D, respectively). An angle of 0 deg corresponds to pure forward movement and an angle of 90 deg represents pure sideward movement.

The goal direction during the return flight is determined according to this scheme at any location as a difference between the average landmark vector previously determined at the goal location and the vector determined at the current location (Lambrinos et al., 2000). This kind of mechanism could be shown in model simulations to be

sufficient to account, within a catchment area, for local homing, i.e. for the return of the agent back to its goal (Lambrinos et al., 2000; Möller, 2000; Stürzl and Mallot, 2006). The size and shape of the catchment area depends on both the environment and the local homing mechanism. Note that all these mechanisms referred to

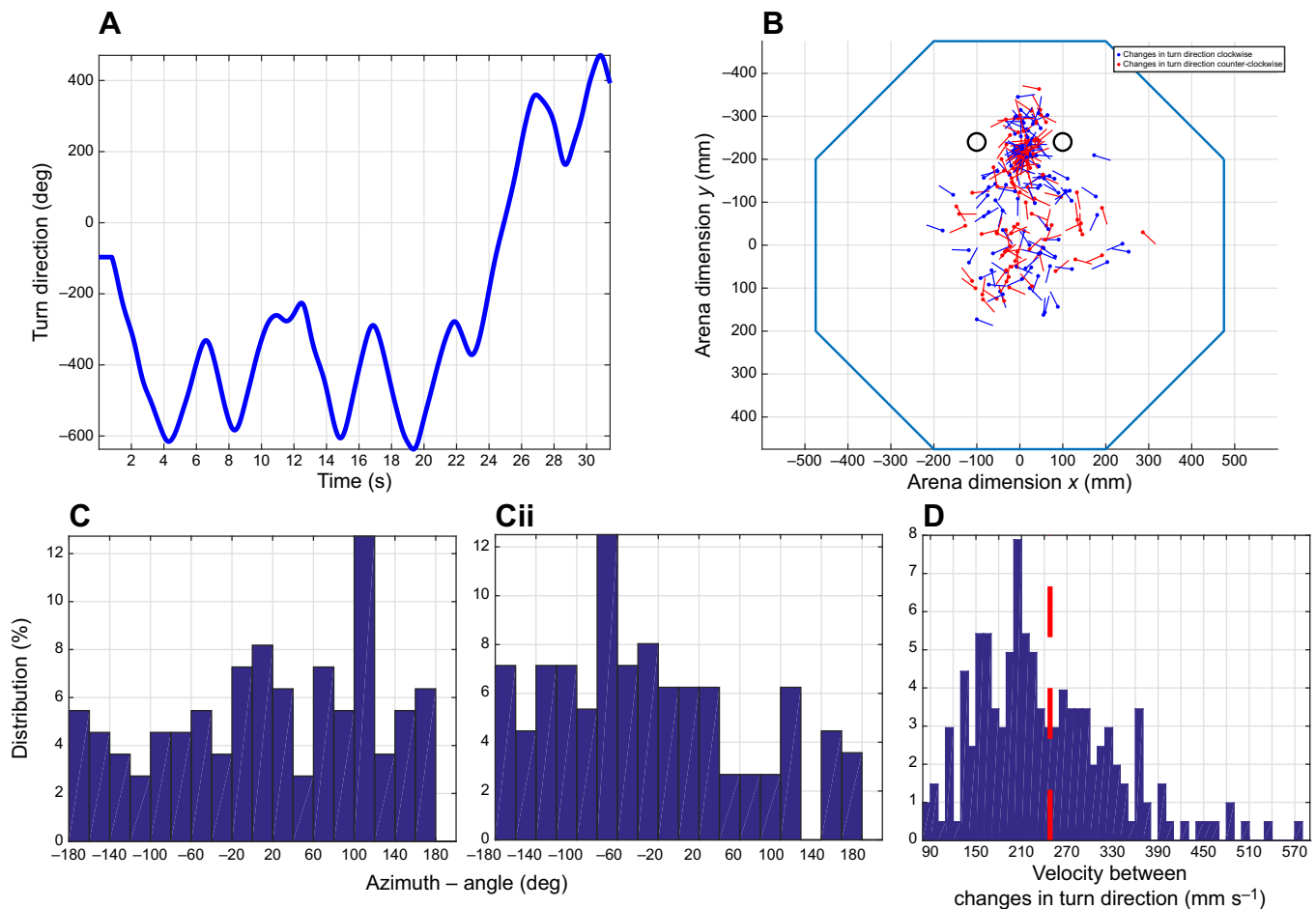

**Fig. 10. Changes in turn direction of body orientation.** (A) Turn direction of body orientation of a bumblebee's first departure flight as a function of time. (B) Locations of changes in turn direction from clockwise to counter-clockwise and *vice versa*. Clockwise and counter-clockwise turns for the first departure flight of all bumblebees in phase 1 (below 100 mm). Black circles indicate cylinders.  $N=21$  first departure flights. Bumblebee 'architecture': filled circle, head; line, orientation of body-length axis. (C) Retinal position of the nest at clockwise and counter-clockwise changes in turn direction (CTD) for the first outbound flight below 100 mm. (Ci) clockwise CTD, number of CTD is 106, (Cii) counter-clockwise CTD, number of CTD is 107.  $N=21$  first departure flights. (D) Flight velocity between CTD for the first outbound flight, below 100 mm, number of CTD is 195. Dashed line indicates mean of velocity.  $N=21$  first departure flights.

above only account for local homing, i.e. finding the location of a virtually invisible goal within the vicinity defined by its catchment area. Local homing only represents one phase, although an important one, of the navigation behaviour of bumblebees and many ant species. Navigation takes place on a large range of spatial scales, as has already been addressed in the Introduction, and, accordingly, a variety of mechanisms of route learning partly combined with odometry have been proposed that help the animals to find their routes back into the immediate vicinity of the goal, where the local homing mechanisms take over (e.g. Baddeley et al., 2012; Capaldi and Dyer, 1999; Capaldi et al., 2000; Collett et al., 2014; Dewar et al., 2014; Knaden and Graham, 2016; Müller and Wehner, 2010; Müller et al., 2017; Narendra et al., 2013; Osborne et al., 2013; Woodgate et al., 2016).

All the models mentioned for the explanation of local homing in insects, i.e. their final approach to their goal completing a longer excursion, have in common that the information that is later used for returning to the goal is goal centred, i.e. gathered locally at the goal location. These explanatory models, although they can explain local homing, seem to be somehow in disagreement with the concept of learning flights, where the insect is thought not to gather the relevant information just at the goal location but during

the entire initial flight section (e.g. corresponding to our flight phase 1) after leaving the nest hole. On the one hand, it might be plausible that insects learn during the entire initial section of departure flights from the goal, because of the animal's heading direction during such flights: wasps (Collett and Lehrer, 1993; Stürzl et al., 2016; Zeil, 1993), honeybees (Dittmar et al., 2010, 2011; Lehrer, 1991, 1993; Lehrer and Collett, 1994) and bumblebees (Collett et al., 2013; Hempel de Ibarra et al., 2009; Philippides et al., 2013; Riabinina et al., 2014) tend to orientate towards the goal location, such as the nest hole or a food source, for quite some time during the initial sections of their departure flights. On the other hand, why should insects spend energy and time to perform a complex sequence of movements to gather information near their goal if one single goal-centred panoramic is already sufficient for a successful return? This issue is further accentuated not only by the high degree of inter-individual variability in the individual flight patterns of bumblebees as characterised here but also between consecutive outbound flights of individual bees (A.L., R.K. and M.E., in preparation), although there are obvious differences between different hymenopteran species in this regard (wasps: Collett and Lehrer, 1993; Zeil, 1993; honeybees: Lehrer and Collett, 1994).



The variability of the initial phase of outbound flights across bumblebees was investigated systematically in the present study: although the overall flight structures differ tremendously between individuals, there are still common behavioural motifs in almost all outbound flights. Bumblebees leave the nest hole and spend the initial sections of departure close to the goal. They also roughly keep the nest hole region in their frontal visual field during periods in this initial section of the departure flights. Although the corresponding flight sections reveal a consistent spatial relationship to the nest hole and its vicinity, they are broadly spread in space in individual flights. After some time, the bees increase height and distance to their nest hole by performing loop-like manoeuvres. Thereby, the overall flight trajectories shift towards the centre of the flight arena. Although we cannot exclude that the spatio-temporal details of the initial phase of departure flights may depend on the specifics of the experimental set-up (e.g. its ground texture), our findings are in accordance with what has been described for bumblebees in other experimental settings, including semi-natural surroundings (Collett et al., 2013; Hempel de Ibarra et al., 2009; Philippides et al., 2013; Riabinina et al., 2014).

The retinal location of the nest hole during the initial sections of departure flights might also play a role as a kind of trigger in bumblebees for changing the turn direction, as has been proposed for solitary wasps (Stürzl et al., 2016; Zeil et al., 1993). However, the pattern of locations of changes in flight direction is highly variable in bumblebees: these locations may be almost anywhere in the flight arena covered by the flight trajectories. Additionally, the fine structure of the flights does not reveal obvious similarities between different bumblebees' flight manoeuvres. As the environment was kept constant in our experiments, this high variability can hardly be explained by the flexibility needed for an innate behavioural learning programme and the adaptivity of individuals to specific unpredictable environmental situations.

The spatio-temporal characteristics of departure flights and, especially, the non-existence of a consistent pattern in their fine structure and the great inter-individual variability led us to a new hypothesis regarding the functional significance of the departure flights. We hypothesise that bumblebees gather information only during the very initial section of the flights, while they are still very close to the goal. In this section, it is suggested they determine a dynamic representation of the surroundings as seen from a very small region around the goal ('goal-centred dynamic snapshot') that determines the catchment area in the vicinity of the nest hole. The later flight sections of phase 1 of the departure flights (according to our classification explained in the Results) are then hypothesised to be employed to probe the quality and usefulness of this goal-centred information and the catchment area around the nest location. This means that the bumblebee moves in a loop-like manner to somehow 'simulate' a return flight to the nest after the foraging trip to find out whether the information provided by the goal-centred dynamic snapshot is sufficient to eventually find the nest hole again. This behaviour might, thus, also be understood as an information gathering process; however, not information about the nest hole location itself but rather the reliability of the goal-centred dynamic snapshot and the validity of the catchment area. A similar hypothesis has been proposed by Stürzl and Zeil (2007). They suggested that the behaviour during acquisition of a visual representation of the environment around the goal might reflect a need for 'quality assurance' and the insects, therefore, may continuously check by moving and comparing whether the representation they have acquired is robust and informative enough for a successful return.

According to the hypothesis above, the initially naïve insects at the very beginning of their first outbound flight might gather information about the surroundings of the nest entrance only very locally, i.e. from a nest-centred perspective, rather than during the entire phase 1 of the departure flights. Still, they might not take only a kind of stationary panoramic snapshot, as is usually assumed in local homing models (see above). Bumblebees are assumed to have to move in the close vicinity of the nest hole: they need to turn around to get panoramic information about the environment. These rotations should be interspersed with brief translational flight intervals (e.g. intersaccadic intervals) if the animal also needs to extract information about the spatial layout of the environment from the perspective of the nest hole. All this information might then be combined into a goal-centred representation of the behaviourally relevant environmental information. This information may then be employed as a basis of some local homing mechanism (see above). Further experiments are required, which focus on the very initial phase of the departure flights while the bees move very close to the nest location; a high spatial resolution is then required to allow us to resolve both body and head orientation in greater detail. This detailed analysis is not yet possible on this basis, because our current analysis covered the entire departure flights.

Overall, our hypotheses suggest that [in accordance with the common local homing models (see above)] goal-centred information is sufficient to guide the insect back to its home location on the return flights. If this were correct, the inter-individual variability observed in the overall flight patterns would not be deleterious, because most of this part of the departure flights was not a component of a learning routine but would just serve to probe the catchment area. This can, in principle, be done either systematically or by a somehow random procedure. This issue needs to be tested in further modelling analyses. In any case, as a consequence of such a scheme, the variability of departure flights is probably not to be the outcome of some kind of noise originating at any information processing stage in the nervous system but part of a strategy probing the usefulness of the information acquired before at the goal location.

Upcoming studies investigating the initial learning behaviour in hymenopterans must be designed in a way to test whether the phases after the initial sections of departure flights serve as a measure of the reliability of the catchment area using goal-centred dynamic information about the goal environment, actively gathered very close to the goal location.

#### Acknowledgements

We thank Jens P. Lindemann for the tracking software ivTrace. In addition, we thank Olivier Bertrand for helpful advice and support in analysing the data, and Tim Siesenop, Jan Wille, Sophie Lehfeldt and Moritz Milde for contributing to this work and their help in the analysing process.

#### Competing interests

The authors declare no competing or financial interests.

#### Author contributions

Conceptualization: A.L., R.K., M.E.; Methodology: A.L.; Validation: R.K., M.E.; Formal analysis: A.L.; Investigation: A.L.; Resources: M.E.; Data curation: A.L.; Writing - original draft: A.L.; Writing - review & editing: R.K., M.E.; Visualization: A.L.; Supervision: R.K., M.E.; Project administration: R.K., M.E.; Funding acquisition: M.E.

#### Funding

This study was supported by the Deutsche Forschungsgemeinschaft (DFG).

#### References

Baddeley, B., Graham, P., Philippides, A. and Husbands, P. (2011). Holistic visual encoding of ant-like routes: navigation without waypoints. *Adapt. Behav.* **19**, 3-15.

- Baddeley, B., Graham, P., Husbands, P. and Philippides, A.** (2012). A model of ant route navigation driven by scene familiarity. *PLoS Comput. Biol.* **8**, e1002336.
- Basten, K. and Mallot, H. A.** (2010). Simulated visual homing in desert ant natural environments: efficiency of skyline cues. *Biol. Cybern.* **102**, 413-425.
- Boeddeker, N., Dittmar, L., Stürzl, W. and Egelhaaf, M.** (2010). The fine structure of honeybee head and body yaw movements in a homing task. *Proc. R. Soc. Lond. B Biol. Sci.* **277**, 1899-1906.
- Boeddeker, N., Mertes, M., Dittmar, L. and Egelhaaf, M.** (2015). Bumblebee homing: the fine structure of head turning movements. *PLoS ONE* **10**, e0135020.
- Bouquet, J.** (1999). Visual methods for three-dimensional modeling. PhD Thesis, California Institute of Technology. Available at: [http://www.vision.caltech.edu/publications/phdthesis\\_jybouquet.pdf](http://www.vision.caltech.edu/publications/phdthesis_jybouquet.pdf)
- Braun, E., Geurten, B. and Egelhaaf, M.** (2010). Identifying prototypical components in behaviour using clustering algorithms. *PLoS ONE* **5**, e9361.
- Braun, E., Dittmar, L., Boeddeker, N. and Egelhaaf, M.** (2012). Prototypical components of honeybee homing flight behaviours depend on the visual appearance of objects surrounding the goal. *Front. Behav. Neurosci.* **6**, 1.
- Buehlmann, C., Woodgate, J. L. and Collett, T. S.** (2016). On the encoding of panoramic visual scenes in navigating wood ants. *Curr. Biol.* **26**, 2022-2027.
- Capaldi, E. A. and Dyer, F. C.** (1999). The role of orientation flights on homing performance in honeybees. *J. Exp. Biol.* **202**, 1655-1666.
- Capaldi, E. A., Smith, A. D., Osborne, J. L., Fahrbach, S. E., Farris, S. M., Reynolds, D. R., Edwards, A. S., Martin, A., Robson, G. E., Poppy, G. M. et al.** (2000). Ontogeny of orientation flight in the honeybee revealed by harmonic radar. *Nature* **403**, 537-540.
- Cartwright, B. A., Collett, T. S.** (1987). Landmark maps for honeybees. *Biol. Cybern.* **57**, 85-93.
- Collett, T. S. and Collett, M.** (2002). Memory use in insect navigation. *Nat. Rev. Neurosci.* **3**, 542-552.
- Collett, T. S. and Lehrer, M.** (1993). Looking and learning: a spatial pattern in the orientation flight of the wasp *Vespa vulgaris*. *Proc. R. Soc. Lond. B Biol. Sci.* **252**, 129-134.
- Collett, T. S. and Zeil, J.** (1996). Flights of learning. *Curr. Dir. Psychol. Sci.* **5**, 149-155.
- Collett, T. S., Graham, P. and Durier, V.** (2003). Route learning by insects. *Curr. Opin. Neurobiol.* **13**, 718-725.
- Collett, M., Collett, T. S. and Srinivasan, M. V.** (2006a). Insect navigation: measuring travel distance across ground and through air. *Curr. Biol.* **16**, 887-890.
- Collett, T. S., Graham, P., Harris, R. A. and Hempel de Ibarra, N.** (2006b). Navigational memories in ants and bees: memory retrieval when selecting and following routes. *Adv. Study Behav.* **36**, 123-172.
- Collett, T. S., Hempel de Ibarra, N., Riabinina, O. and Philippides, A.** (2013). Coordinating compass-based and nest-based flight directions during bumblebee learning and return flights. *J. Exp. Biol.* **216**, 1105-1113.
- Collett, T. S., Lent, D. D. and Graham, P.** (2014). Scene perception and the visual control of travel direction in navigating wood ants. *Phil. Trans. R. Soc. Lond. B Biol. Sci.* **369**, 20130035.
- Dewar, A. D. M., Philippides, A. and Graham, P.** (2014). What is the relationship between visual environment and the form of ant learning-walks? An in silico investigation of insect navigation. *Adapt. Behav.* **22**, 163-179.
- Dittmar, L., Stürzl, W., Baird, E., Boeddeker, N. and Egelhaaf, M.** (2010). Goal seeking in honeybees: matching of optic flow snapshots. *J. Exp. Biol.* **213**, 2913-2923.
- Dittmar, L., Egelhaaf, M., Stürzl, W. and Boeddeker, N.** (2011). The behavioural relevance of landmark texture for honeybee homing. *Front. Behav. Neurosci.* **5**, 20.
- Egelhaaf, M.** (2009). Insect motion vision. *Scholarpedia* **4**, 1671.
- Egelhaaf, M., Boeddeker, N., Kern, R., Kurtz, R. and Lindemann, J. P.** (2012). Spatial vision in insects is facilitated by shaping the dynamics of visual input through behavioural action. *Front. Neural Circuits* **6**, 108.
- Freas, C. A., Whyte, C. and Cheng, K.** (2017). Skyline retention and retroactive interference in the navigating Australian desert ant, *Melophorus bagoti*. *J. Comp. Physiol. A Neuroethol. Sens. Neural. Behav. Physiol.* **203**, 353-367.
- Geurten, B. R. H., Kern, R., Braun, E. and Egelhaaf, M.** (2010). A syntax of hoverfly flight prototypes. *J. Exp. Biol.* **213**, 2461-2475.
- Gibson, J. J.** (1950). *The Perception of the Visual World*. Boston, MA: Houghton Mifflin.
- Gibson, J. J.** (1979). *The Ecological Approach to Visual Perception*. Boston, MA: Houghton Mifflin.
- Graham, P. and Cheng, K.** (2009). Ants use the panoramic skyline as a visual cue during navigation. *Curr. Biol.* **19**, 935-937.
- Hempel de Ibarra, N., Philippides, A., Riabinina, O. and Collett, T. S.** (2009). Preferred viewing directions of bumblebees (*Bombus terrestris* L.) when learning and approaching their nest site. *J. Exp. Biol.* **212**, 3193-3204.
- Knaden, M. and Graham, P.** (2016). The sensory ecology of ant navigation: from natural environments to neural mechanisms. *Annu. Rev. Entomol.* **61**, 63-76.
- Kollmeier, T., Röben, F., Schenck, W. and Möller, R.** (2007). Spectral contrasts for landmark navigation. *J. Opt. Soc. Am. A* **24**, 1-10.
- Lambrinos, D., Möller, R., Labhart, T., Pfeifer, R. and Wehner, R.** (2000). A mobile robot employing insect strategies for navigation. *Rob. Auton. Syst.* **30**, 39-64.
- Lehrer, M.** (1991). Bees which turn back and look. *Naturwissenschaften* **78**, 274-276.
- Lehrer, M.** (1993). Why do bees turn back and look? *J. Comp. Physiol. A* **172**, 549-563.
- Lehrer, M. and Collett, T. S.** (1994). Approaching and departing bees learn different cues to the distance of a landmark. *J. Comp. Physiol. A* **175**, 171-177.
- Lindemann, J.** (2005). *Visual navigation of a virtual blowfly*. PhD Thesis, Universität Bielefeld, Germany.
- Möller, R.** (2000). Insect visual homing strategies in a robot with analog processing. *Biol. Cybern.* **83**, 231.
- Müller, M. and Wehner, R.** (2010). Path integration provides a scaffold for landmark learning in desert ants. *Curr. Biol.* **20**, 1368-1371.
- Müller, J., Nawrot, M., Menzel, R. and Landgraf, T.** (2017). A neural network model for familiarity and context learning during honeybee foraging flights. *Biol. Cybern.*
- Narendra, A., Gourmaud, S. and Zeil, J.** (2013). Mapping the navigational knowledge of individually foraging ants, *Myrmecia croslandi*. *Proc. R. Soc. Lond. B Biol. Sci.* **280**, 20130683.
- Osborne, J. L., Smith, A., Clark, S. J., Reynolds, D. R., Barron, M. C., Lim, K. S. and Reynolds, A. M.** (2013). The ontogeny of bumblebee flight trajectories: from naïve explorers to experienced foragers. *PLoS ONE* **8**, e78681.
- Philippides, A., Baddeley, B., Cheng, K. and Graham, P.** (2011). How might ants use panoramic views for route navigation? *J. Exp. Biol.* **214**, 445-451.
- Philippides, A., Hempel de Ibarra, N., Riabinina, O. and Collett, T. S.** (2013). Bumblebee calligraphy: the design and control of flight motifs in the learning and return flights of *Bombus terrestris*. *J. Exp. Biol.* **216**, 1093-1104.
- Riabinina, O., Hempel de Ibarra, N. H., Philippides, A. and Collett, T. S.** (2014). Head movements and the optic flow generated during the learning flights of bumblebees. *J. Exp. Biol.* **217**, 2633-2642.
- Schilstra, C. and van Hateren, J. H.** (1999). Blowfly flight and optic flow. I. Thorax kinematics and flight dynamics. *J. Exp. Biol.* **202**, 1481-1490.
- Skorupski, P., Döring, F. T. and Chittka, L.** (2007). Photoreceptor spectral sensitivity in island and mainland populations of the bumblebee, *Bombus terrestris*. *J. Comp. Physiol. A* **193**, 485-494.
- Srinivasan, M. V.** (1993). How insects infer range from visual motion. In *Visual Motion and Its Role in the Stabilization of Gaze* (ed. F. A. Miles and J. Wallman), pp. 139-156. Amsterdam: Elsevier Science Publisher B.V.
- Stürzl, W. and Mallot, H. A.** (2006). Efficient visual homing based on Fourier transformed panoramic images. *Rob. Auton. Syst.* **54**, 300-313.
- Stürzl, W. and Zeil, J.** (2007). Depth, contrast and view-based homing in outdoor scenes. *Biol. Cybern.* **96**, 519-531.
- Stürzl, W., Zeil, J., Boeddeker, N. and Hemmi, J. M.** (2016). How wasps acquire and use views for homing. *Curr. Biol.* **26**, 470-482.
- Towne, W. F., Ritrovato, A. E., Esposto, A. and Brown, D. F.** (2017). Honeybees use the skyline in orientation. *J. Exp. Biol.* **220**, 2476-2485.
- Vardy, A. and Möller, R.** (2005). Biologically plausible visual homing methods based on optical flow techniques. *Conn. Sci.* **17**, 47-89.
- Wittlinger, M., Wehner, R. and Wolf, H.** (2006). The ant odometer: stepping on stilts and stumps. *Science* **312**, 1965-1967.
- Wolf, H.** (2011). Odometry and insect navigation. *J. Exp. Biol.* **214**, 1629-1641.
- Woodgate, J. L., Makinson, J. C., Lim, K. S., Reynolds, A. M. and Chittka, L.** (2016). Life-long radar tracking of bumblebees. *PLoS ONE* **11**, e0160333.
- Wystrach, A., Beugnon, G. and Cheng, K.** (2011). Landmarks or panoramas: what do navigating ants attend to for guidance? *Front. Zool.* **8**, 21.
- Zeil, J.** (1993). Orientation flights of solitary wasps (*Cerceris*; Sphecidae; Hymenoptera): I. Description of flight. *J. Comp. Physiol. A* **172**, 189-205.
- Zeil, J. and Wittmann, D.** (1993). Landmark orientation during the approach to the nest in the stingless bee *Trigona (Trigona) angustula* (Apidae, Meliponinae). *Ins. Soc.* **40**, 381-389.
- Zeil, J., Kelber, A. and Voss, R.** (1996). Structure and function of learning flights in ground-nesting bees and wasps. *J. Exp. Biol.* **199**, 245-252.
- Zeil, J., Boeddeker, N., Hemmi, J. M. and Stürzl, W.** (2007). Going wild: toward an ecology of visual information processing. In *Invertebrate Neurobiology* (ed. G. North and R. Greenspan), pp. 381-403. New York: Cold Spring Harbor Press.
- Zeil, J., Boeddeker, N. and Stürzl, W.** (2009). Visual homing in insects and robots. In *Flying Insects and Robots* (ed. D. Floreano, J.-C. Zufferey, M. V. Srinivasan and C. Ellington), pp. 87-100. Heidelberg: Springer Verlag.